

# LIND LUXURY BADEROMSMØBEL

120cm

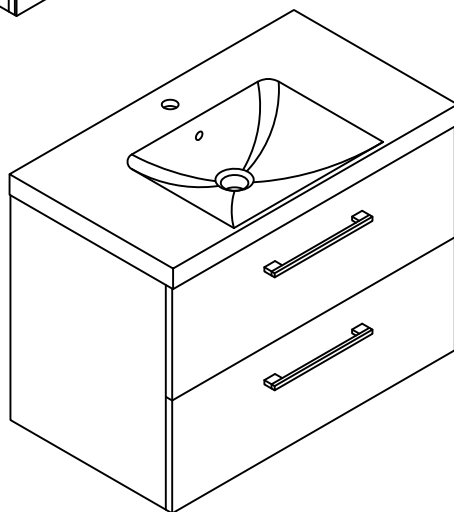

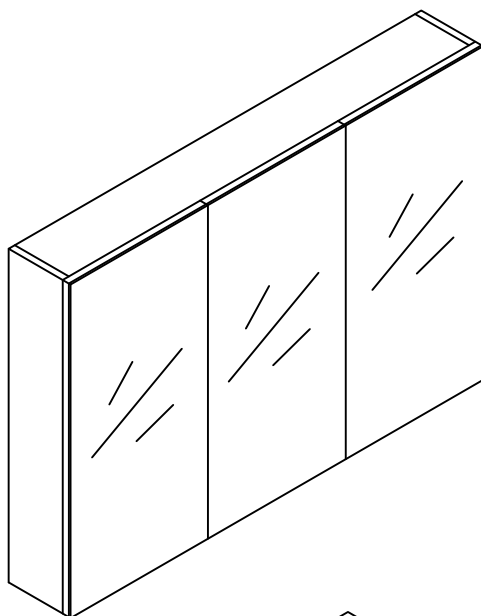

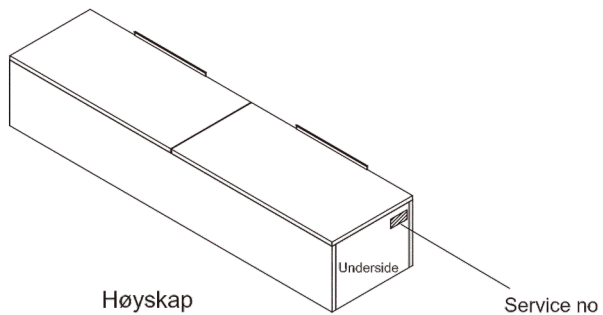
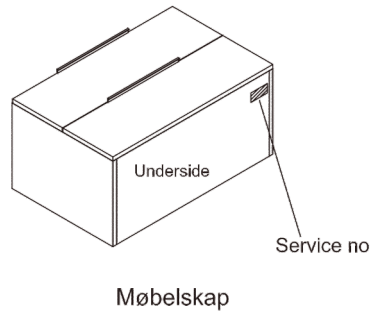
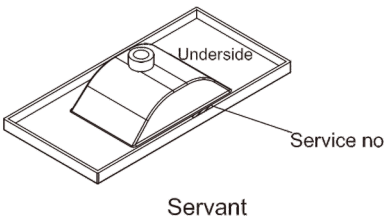
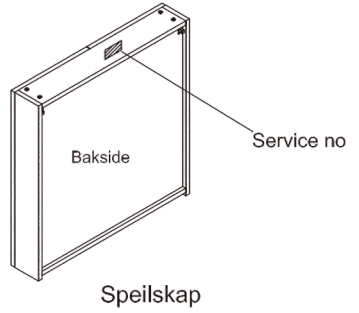
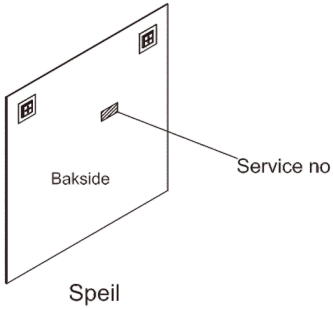

# Lind®

**Vi takker for ditt valg av et Lind badersmøbel.**

**Før du setter i gang med monteringen av dette produktet er det viktig at du får oversikt over alle delene. Bruk god tid til å sette deg inn i hvordan monteringen skal utføres. Det kan være en fordel og være to personer under monteringen.**

### **Viktig å lese før montering**

1. Sjekk at alle nødvendige deler følger med i esken. Dersom noe skulle mangle, kontakt din lokale forhandler eller MegaFis kundeservice og referer til delens delenummer i denne veiledningen.
2. Kontroller at badersmøbelet er uten skade, før monteringen starter.
3. Ved førstegangs montering skal alle skruer på møbelet etter strammes. Dette anbefales det også å gjøre som en del av en årlig inspeksjon.
4. Vær nøye med at utsatte deler som speilflater, glasshyller etc. ikke settes direkte på noen harde flater.
5. Sørg for å ha alt nødvendig verktøy lett tilgjengelig.
6. Enkelte store badersmøbler kan være vanskelig å håndtere alene. Vi anbefaler at dere er to personer under montering av større møbelsett.
7. Husk at kun autorisert håndverker skal koble vann til badersmøbelet.

### **Vedlikehold av møbelskap:**

Møbelskap og fronter består av spon og MDF plate som er behandlet med en laminert overflate. Det er viktig å holde god ventilasjon i rommet og plassere møblene avskjermet fra vannsprut og mulige slag, for å minimere risiko for skader.

Daglig rengjøring gjøres med en myk klut som er fuktet i varmt vann. Ved behov kan det benyttes et mildt rengjøringsmiddel uten slipe- og skuremiddel. Tørk deretter av møbelskapet med en myk klut lett fuktet i rent vann for å unngå skjolder og striper fra rengjøringsmidler. Rengjøringsmidler med slipemiddel, ammoniakk, blekemiddel eller andre sterke oppløsningsmidler må ikke benyttes da de kan skade møbelets overflate.

### **Vedlikehold av servant i keramikk:**

Servanten er fremstilt i keramikk som er godt egnet til badersmøbelservanter. Servanten må ikke benyttes til hårfarging, oppskylling av klær som kan inneholde overflødig fargestoffer og lignende, da dette kan farge av og lage flekker i servanten. Daglig rengjøring foregår ved å tørke av servanten med en myk klut, fuktet i vann og mildt rengjøringsmidler ved behov. Det er viktig at det ikke benyttes sterke kjemikalier som klor, ammoniakk, syre, aceton, kraftige rengjøringsmidler og rengjøringsmidler med slipemidler, på servanten. Hvis det skulle oppstå en liten ripe i servantens overflate, så kan man prøve å bruke et keramikk viskelær for å fjerne dette.

Produkt har god bestandighet mot fukt, men krever tilstrekkelig utlufting i rommet. Møbelskapet tåler ikke direkte vannsprut over lengre tid.

**Lykke til med monteringen!**



# Lind®

**Vi tackar dig för ditt val av Lind-badrumsmöbler.**

**Innan du börjar montera produkten är det viktigt att du får en översikt över alla delar. Spendera god tid på att bekanta dig med hur du monterar. Det kan vara en fördel och vara två personer under montering.**

### **Viktigt att läsa Innan montering**

1. Kontrollera att alla nödvändiga delar ingår i rutan. Om något saknas, kontakta din lokala återförsäljare eller MegaFlis kundtjänst och hänvisa till artikelnumret i den här guiden.
2. Innan du installerar, se till att badrumsmöblerna är fria från skador.
3. När du installerar först, dra åt alla skruvar på möblerna. Detta rekommenderas också som en del av en årlig inspektion.
4. Var försiktig så att du inte placerar utsatta delar som spegelytor, glashyllor etc. direkt på hårda ytor.
5. Se till att alla nödvändiga verktyg är lätt tillgängliga.
6. Vissa stora badrumsmöbler kan vara svåra att hantera ensamma. Vi rekommenderar att du är två personer när du installerar större möbler.
7. Kom ihåg att endast auktoriserade hantverkare ska ansluta vatten till badrumsmöblerna.

### **Tips:**

#### **Möblerunderhåll:**

Möbelskåp och fronter består av spån och MDF-plåt som är behandlade med en laminerad yta. Det är viktigt att hålla god ventilation i rummet och placera möblerna skyddade mot vattenstänk och möjliga slag för att minimera risken för skador.

Daglig rengöring görs med en mjuk trasa fuktad i varmt vatten. Vid behov kan ett mildt tvättmedel användas utan slipmedel och slipmedel. Torka sedan av möbelskåpet med en mjuk trasa lätt fuktad med rent vatten för att undvika fläckar och fläckar från rengöringsprodukter. Använd inte slipmedel, ammoniak, blekmedel eller andra starka lösningsmedel eftersom de kan skada möbels yta.

#### **Underhåll av keramisk handfat:**

Tvättstället är tillverkat i keramik som passar bra för badrumsfat. Handfat får inte användas för hårfärgning, sköljning av kläder som kan innehålla överskottsfärgämnen och liknande, eftersom det kan färga och göra fläckar i tvättstället. Daglig rengöring görs genom att torka av handfat med en mjuk trasa, fuktad med vatten och mildt tvättmedel vid behov. Det är viktigt att starka kemikalier som klor, ammoniak, syra, aceton, kraftfulla tvättmedel och slipmedel inte används på tvättstället. Om det uppstår en liten repa på tvättställets yta kan du försöka använda ett keramiskt radergummi för att ta bort det.

Produkten har god fuktbeständighet, men kräver tillräcklig ventilation i rummet.

Möbelföretaget tål inte direkt vattenstänk på länge.

**Lycka till med monteringen!**



# Lind®

## Dziękujemy za wybór mebli łazienkowych Lind.

**Przed rozpoczęciem montażu tego produktu ważne jest, aby uzyskać przegląd wszystkich części. Poświęć dużo czasu na zapoznanie się z montażem. Może to być zaletą być dwiema osobami podczas montażu.**

### Ważne, aby przeczytać przed montażem

1. Sprawdź, czy wszystkie niezbędne części znajdują się w pudełku. Jeśli czegoś brakuje, skontaktuj się z lokalnym sprzedawcą lub obsługą klienta MegaFlis i zapoznaj się z numerem części w tym przewodniku.
2. Przed instalacją upewnij się, że meble łazienkowe nie są uszkodzone.
3. Podczas pierwszej instalacji dokręć wszystkie śruby w meblach. Jest to również zalecane w ramach corocznej kontroli.
4. Uważaj, aby nie umieszczać odstłoniętych części, takich jak lustrzane powierzchnie, szklane półki itp. Bezpośrednio na twardych powierzchniach.
5. Upewnij się, że masz wszystkie niezbędne narzędzia łatwo dostępne.
6. Niektóre duże meble łazienkowe mogą być trudne w obsłudze samodzielnie. Podczas instalowania większych zestawów mebli zalecamy dwie osoby.
7. Pamiętaj, że tylko uprawnieni rzemieślnicy powinni podłączać wodę do mebli łazienkowych.

### Konserwacja mebli:

Szafki meblowe i fronty składają się z płyty wiórowej i płyty MDF, które są pokryte laminowaną powierzchnią. Ważne jest, aby utrzymać dobrą wentylację w pomieszczeniu i umieścić meble w miejscu chronionym przed rozpryskami wody i możliwymi uderzeniami, aby zminimalizować ryzyko obrażeń.

Codziennie czyszczenie odbywa się za pomocą miękkiej ściereczki zwilżonej ciepłą wodą. W razie potrzeby można użyć łagodnego detergentu bez środków ściernych i ściernych. Następnie przetrzyj meble miękką ściereczką lekko zwilżoną czystą wodą, aby uniknąć plam i plam z produktów czyszczących. Nie używaj materiałów ściernych, amoniaku, wybielaczy ani innych silnych rozpuszczalników, ponieważ mogą one uszkodzić powierzchnię mebli.

### Konserwacja umywalki ceramicznej:

Umywalka wykonana jest z ceramiki, która doskonale nadaje się do umywalk łazienkowych. Umywalka nie może

stosowany do farbowania włosów, płukania odzieży, która może zawierać nadmiar barwników itp., ponieważ może to zabarwić i przebarwić umywalkę. Codzienne czyszczenie odbywa się poprzez przetarcie umywalki miękką ściereczką zwilżoną wodą i łagodnym detergentem, jeśli to konieczne. Ważne jest, aby w umywalce nie były stosowane silne chemikalia, takie jak chlor, amoniak, kwas, aceton, silne środki czyszczące i ścierne.

Jeśli na powierzchni umywalki pojawi się niewielkie zadrapanie, możesz spróbować użyć ceramicznej gumki do usunięcia.

Produkt ma dobrą odporność na wilgoć, ale wymaga odpowiedniej wentylacji w pomieszczeniu.

Firma meblarska nie jest w stanie wytrzymać bezpośrednich rozprysków wody przez długi czas.

### Powodzenia w montażu!



**We thank you for your choice of a Lind bathroom furniture.**

**Before you begin mounting this product, it is important that you get an overview of all the parts. Take time to familiarize yourself with how to mount the product. It can be an advantage and be two people during assembly.**

#### **Important to read before mounting**

1. Check that all necessary parts are included in the box. If anything is missing, contact your local dealer or MegaFlis customer service and refer to the part number in this guide.
2. Before installing, make sure bathroom furniture is not damaged.
3. When first installing, tighten all screws on furniture. This is also recommended to do as part of an annual inspection.
4. Be careful not to place exposed parts such as mirror surfaces, glass shelves etc. directly on any hard surfaces.
5. Make sure you have all the necessary tools available.
6. Some large bathroom furniture can be difficult to handle alone. We recommend that you are two persons when installing larger furniture sets.
7. Remember that only an authorized installer should connect water to bathroom furniture.

#### **Furniture maintenance:**

Furniture cabinets and fronts consist of chipboard material and MDF plate that is coated with a laminated surface. It is important to maintain good ventilation in the room and to place the furniture away from water splashes and possible impact damage, to minimize the risk of injury.

Daily cleaning is done with a soft cloth dampened in warm water. If required, a mild detergent without grain can be used. Then wipe the furniture with a soft cloth lightly moistened with clean water to avoid any stains from cleaning agents. Do not use abrasives, ammonia, bleach or other strong solvents as they may damage the surface of the furniture.

#### **Maintenance of ceramic washbasin:**

The washbasin is made of ceramic that is well suited for bathroom sinks. The washbasin must not

used for hair dyeing, rinsing of clothes that may contain dyes and the like, as this can color and make spots in the washbasin. Daily cleaning is done by wiping the washbasin with a soft cloth, moistened with water and mild detergent if needed. It is important that strong chemicals such as chlorine, ammonia, acid, acetone, powerful cleaners and abrasive cleaners are not used on the washbasin.

If a small scratch occurs in the washbasin surface, you can try using a ceramic eraser to remove it.

Product has good resistance to moisture, but requires ventilation in the room.

The furniture company cannot withstand direct water splashes for a long time.

**Good luck with the mounting!**

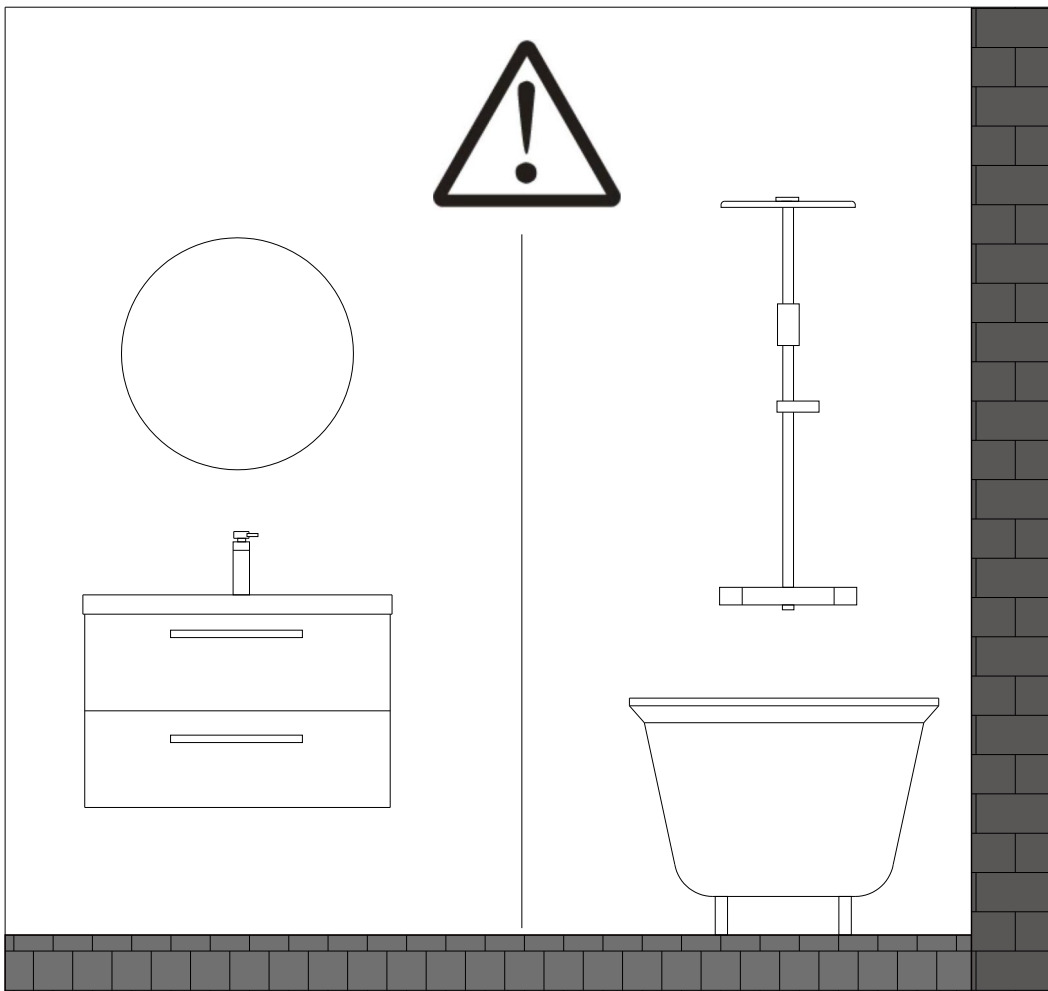

- (NO) Møbelet må monteres uten risiko for direkte vannsprut fra dusjsone.
- (SE) Möblerna måste monteres utan risk för direkt vattenstänk från duschzonen.
- (PL) Mebel należy montować bez ryzyka bezpośredniego wycieku wody ze strefy prysznicza.
- (GB) The furniture must be installed without risk of direct water spillage from the shower zone.



**NB!**

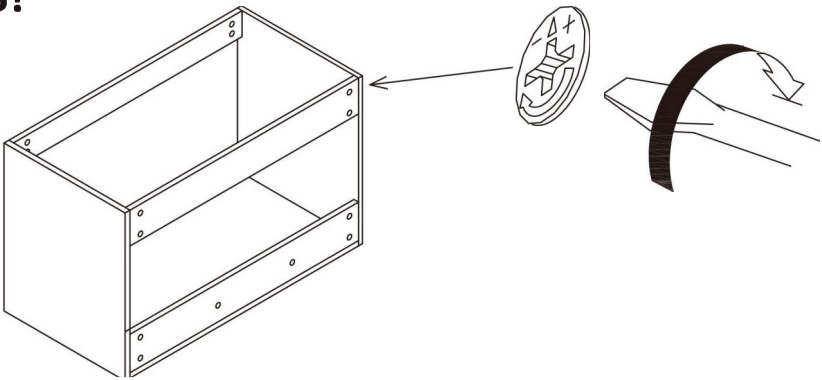

**NO - ETTERSTRAM FESTESKRUENE FØR MONTERING**

**SE - DRAAT FASTER NA INNAN MONTERING**

**PL - DOKRŁC SRUBY MOCUJĄCE PRZED MONTAZEM**

**GB - TIGHTEN THE FASTENINGSCREWS BEFORE MOUNTING**

**DK - SPÆND SKRUER INDEN MONTERING**





NO

Medfølgende skruer og plugg er egnet for tre, gips og betongvegger. Veggene skal være egnet for montering av tynge gjenstander. Undersøk om veggene er egnet for medfølgende skruer og plugg for montering, eventuelt benytt festemidler egnet for din vegg.

SE

De medfølgende skruene og pluggene er lamplige for tre-, gips- og betongvegger. Veggene skal tåle montering av tynge foremal. Kontroller om veggene er lamplige for de medfølgende skruene og pluggene i en montering, anvend fastene som er lamplige for din vegg.

PL

Doś ta rezone w/w śruby i kotki nadaję się do ścian drewnianych, gipsowokartonowych i betonowych. Ściana powinna nadawać się do mocowania ciężkich przedmiotów. Przed montażem sprawdź, czy ścianą nadaje się do odpowiednich śrub i kotków, w miarę możliwości użyj elementów mocujących odpowiednich do ściany.

GB

The supplied screws and plugs are suitable for wood, drywall and concrete walls. The wall should be suitable for mounting heavier objects. Check if the wall is suitable for the supplied screws and plugs before mounting, if possible use fasteners suitable for your wall.

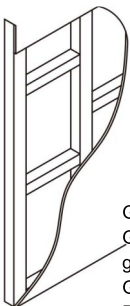

Gipsvegg  
Gipsvagg  
gipsowokartonowych  
Gipsvegg  
Drywall



Trevegg  
Travagg  
ścian drewnianych  
Trævegg  
Woodwall



Betongvegg  
Betongvagg  
Betonowych  
Betonvegg  
Concretwall

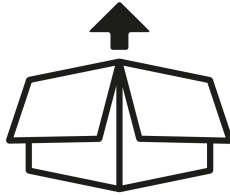

E1



X 4

F1



X 4

J2

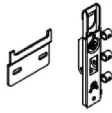

X 2

E4



X 2

J3



X 2

F4









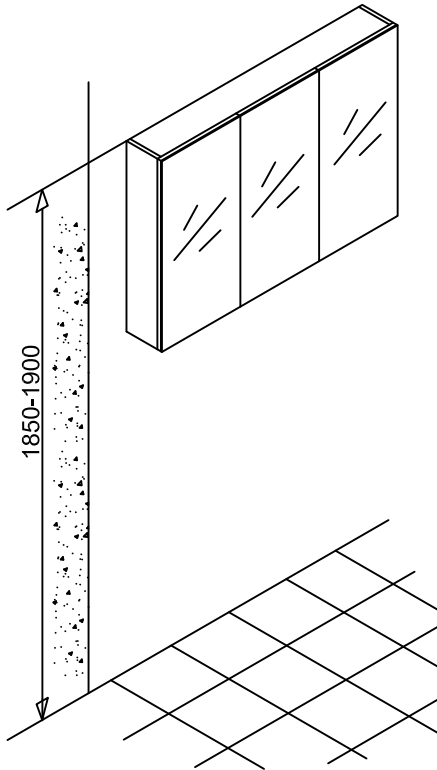
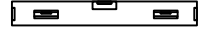
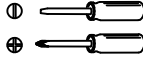
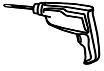

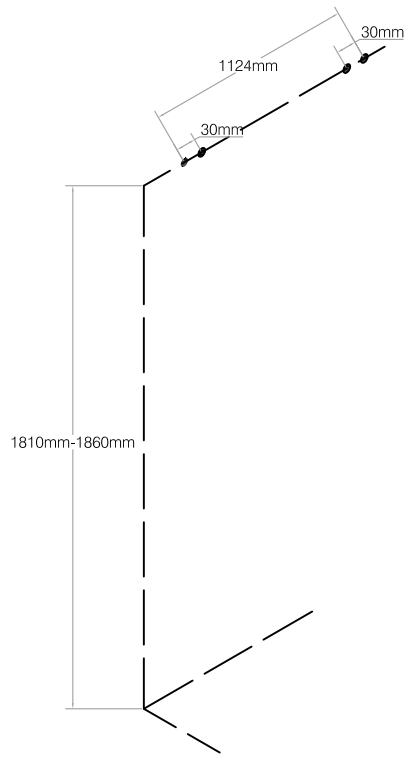
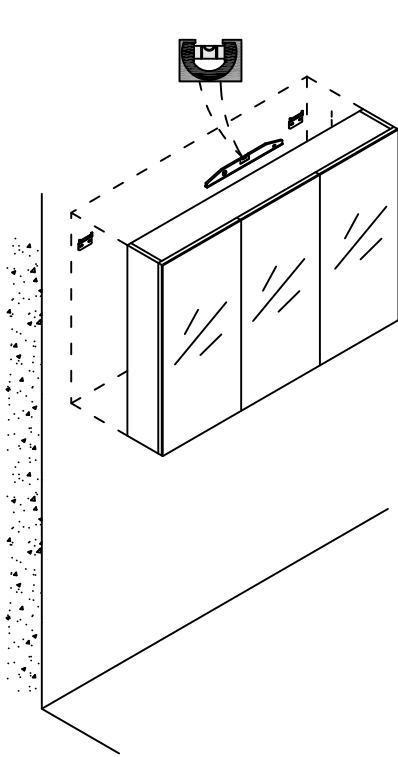
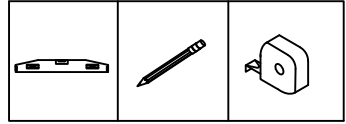
X 2



X 1





J2  X 2	E1  X 4	F1  X 4	E4  X 2	F4  X 2	J3  X 2		
--	--	--	--	--	--	---	---

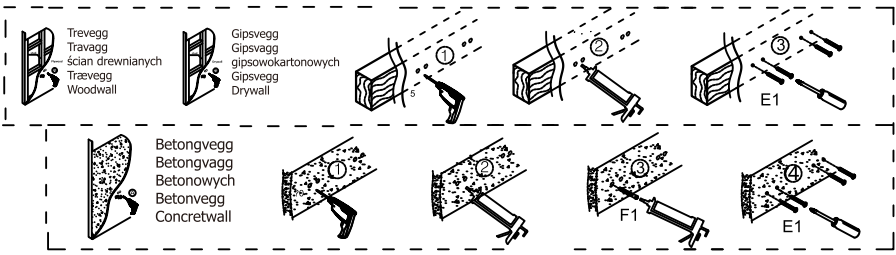
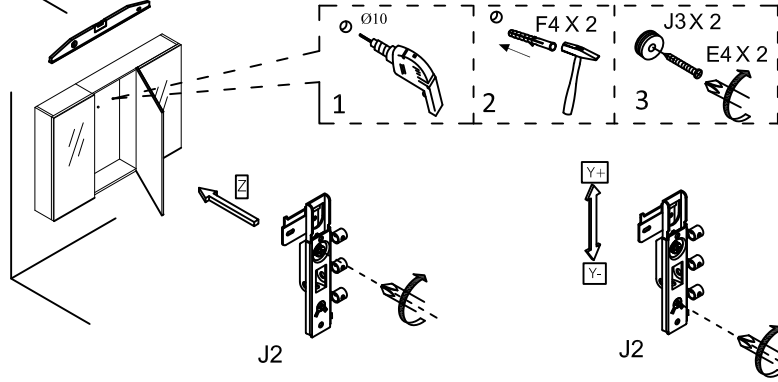
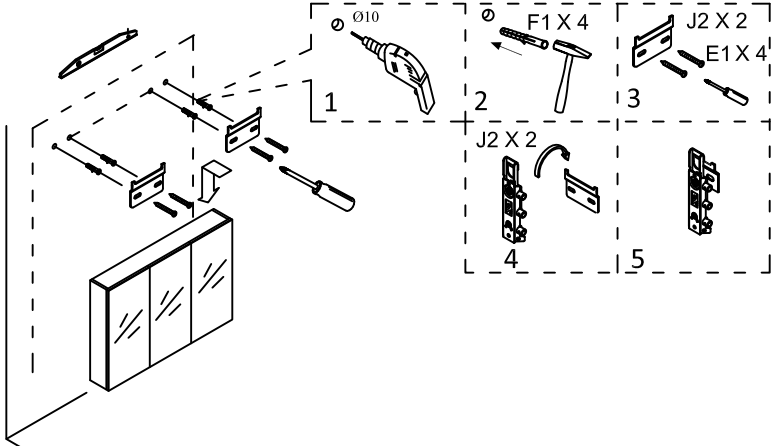
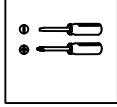

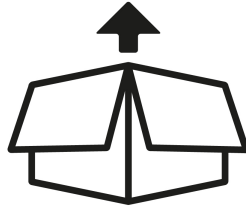

E1



X 4

F1



X 4

J4

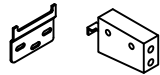

X 2

E4



X 2

F4



X 2

J5

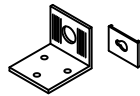

X 2



X 1

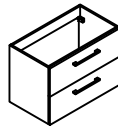

X 1

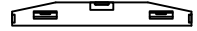
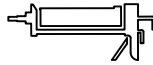
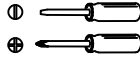
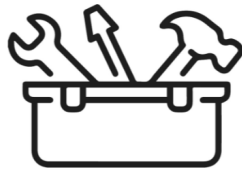



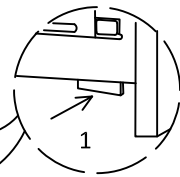
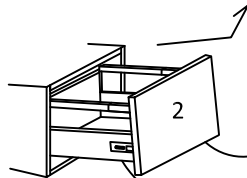
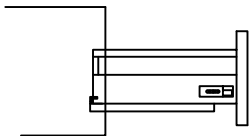
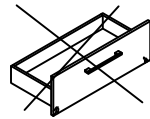
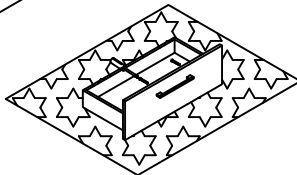
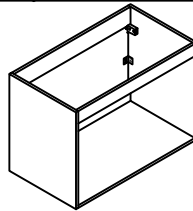
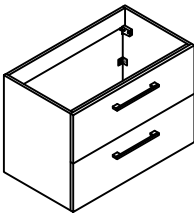
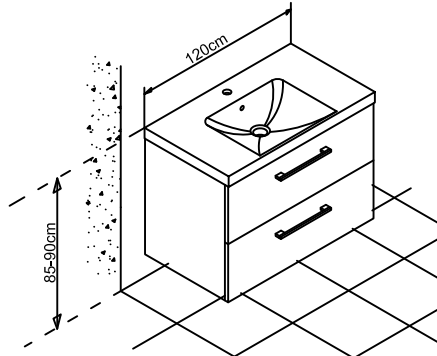

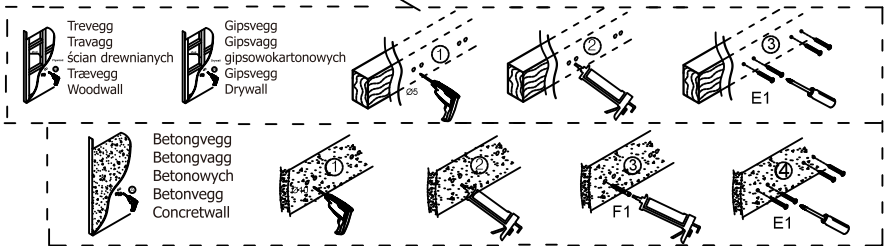
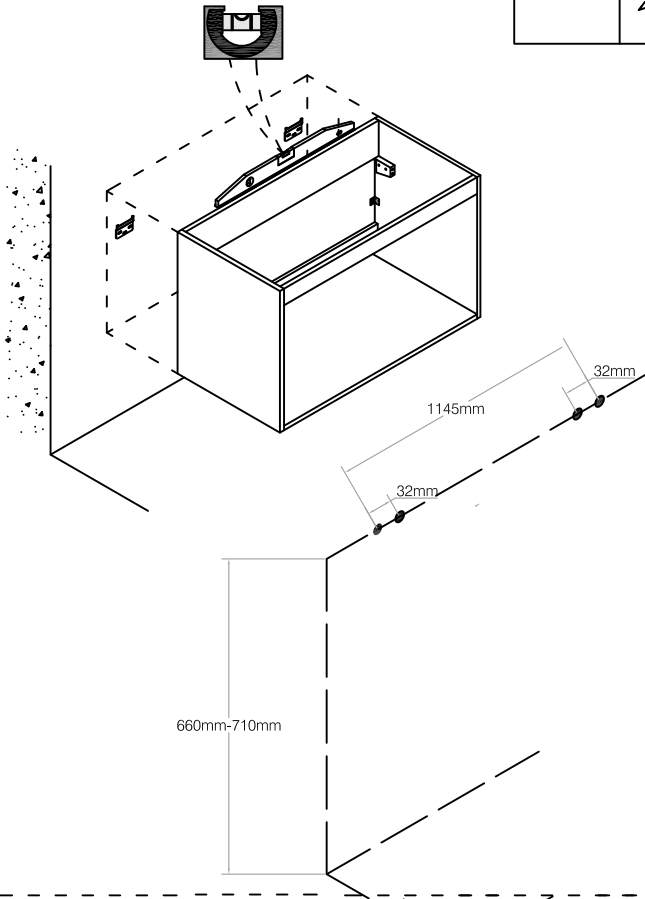
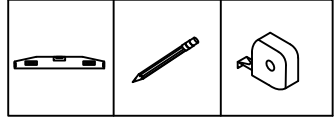



120cm







J4  X 2	E1  X 4	F1  X 4			
E4  X 2	F4  X 2	J5  X 2			

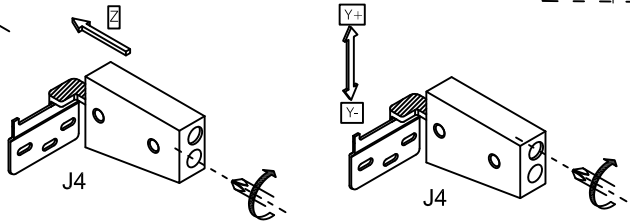
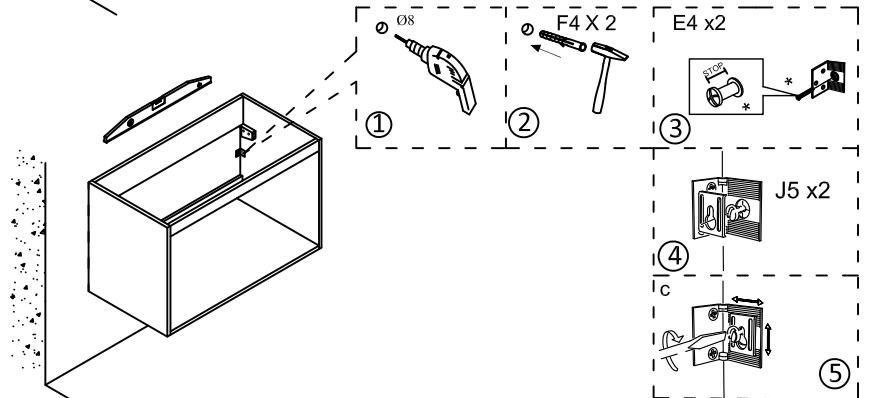
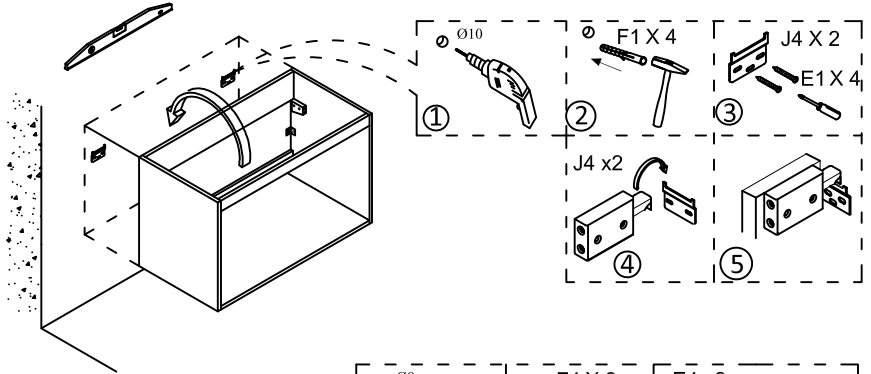

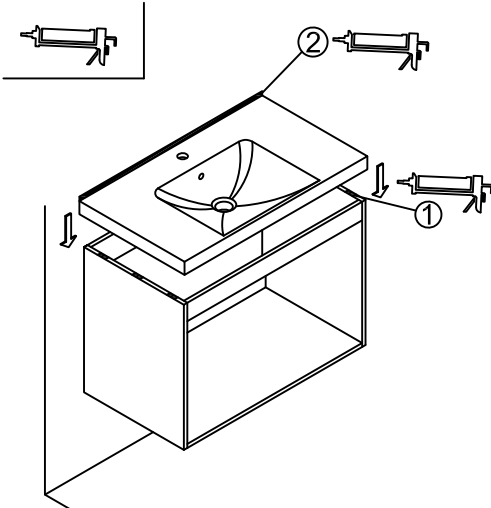

(NO) - Påfør 3 punkter transparent silikon på sidene av møblet samt en stripe på bakside og topp av servanten.

(SE) - Applicera 3 punkter av transparent silikon på sidorna av möblet samt en remsa på baksidan och på toppen av tvättstället.

(PL) - Połóż 3 punkty Drzewoczystego sDlikonu na bocznych listwach mebla oraz dlugi pasek b ezpośrednioDd spodu umywalki.

(GB) - Apply 3 dots of transparent silicone on the sides of the furniture and 1 strip on the back and top of the basin.



4

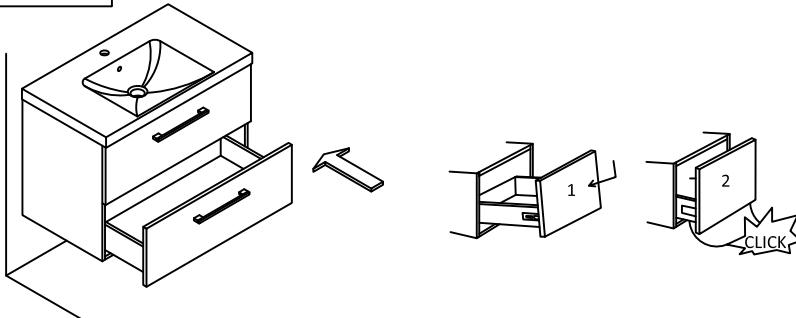
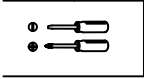

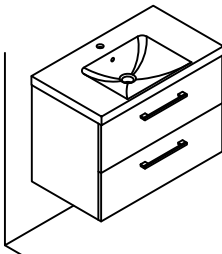

5



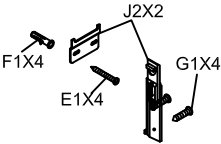
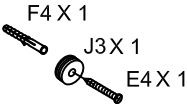
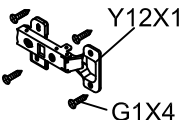
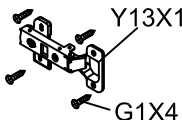

6

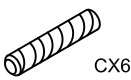
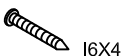
## Monteringssett tilgjengelig i butikk

<p style="text-align: center;"><b>Brakettsett</b></p>  <p style="text-align: center;">Varenummer 0204992706</p>	<p style="text-align: center;"><b>Brakettsett</b></p>  <p style="text-align: center;">Varenummer 0204992687</p>	<p style="text-align: center;"><b>Hengselsett</b></p>  <p style="text-align: center;">Varenummer 0204992669</p>	<p style="text-align: center;"><b>Hengselsett</b></p>  <p style="text-align: center;">Varenummer 0204992688</p>
<p style="text-align: center;"><b>Eksenterboltsett</b></p>  <p style="text-align: center;">Varenummer 0204992670</p>	<p style="text-align: center;"><b>Trepluggsett</b></p>  <p style="text-align: center;">Varenummer 0204992671</p>	<p style="text-align: center;"><b>Skruesett</b></p>  <p style="text-align: center;">Varenummer 0204992689</p>	

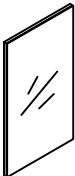
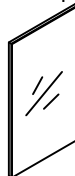
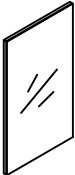
## Reservedeler tilgjengelig for bestilling

<p style="text-align: center;"><b>Venstre speildør</b></p>  <table border="1" style="width: 100%; margin-top: 10px; border-collapse: collapse;"> <thead> <tr> <th style="text-align: left;">Varenummer</th> <th style="text-align: left;">Bestillingsnummer</th> </tr> </thead> <tbody> <tr> <td>Y544-120G</td> <td>022743</td> </tr> <tr> <td>Y544-120B</td> <td>022739</td> </tr> <tr> <td>Y544-120W</td> <td>022745</td> </tr> </tbody> </table>	Varenummer	Bestillingsnummer	Y544-120G	022743	Y544-120B	022739	Y544-120W	022745	<p style="text-align: center;"><b>Midtre speildør</b></p>  <table border="1" style="width: 100%; margin-top: 10px; border-collapse: collapse;"> <thead> <tr> <th style="text-align: left;">Varenummer</th> <th style="text-align: left;">Bestillingsnummer</th> </tr> </thead> <tbody> <tr> <td>Y544-120G</td> <td>022744</td> </tr> <tr> <td>Y544-120B</td> <td>022740</td> </tr> <tr> <td>Y544-120W</td> <td>022746</td> </tr> </tbody> </table>	Varenummer	Bestillingsnummer	Y544-120G	022744	Y544-120B	022740	Y544-120W	022746
Varenummer	Bestillingsnummer																
Y544-120G	022743																
Y544-120B	022739																
Y544-120W	022745																
Varenummer	Bestillingsnummer																
Y544-120G	022744																
Y544-120B	022740																
Y544-120W	022746																
<p style="text-align: center;"><b>Høyre speildør</b></p>  <table border="1" style="width: 100%; margin-top: 10px; border-collapse: collapse;"> <thead> <tr> <th style="text-align: left;">Varenummer</th> <th style="text-align: left;">Bestillingsnummer</th> </tr> </thead> <tbody> <tr> <td>Y544-120G</td> <td>022742</td> </tr> <tr> <td>Y544-120B</td> <td>022741</td> </tr> <tr> <td>Y544-120W</td> <td>022612</td> </tr> </tbody> </table>	Varenummer	Bestillingsnummer	Y544-120G	022742	Y544-120B	022741	Y544-120W	022612	<p style="text-align: center;"><b>Støttekloss</b></p>  <table border="1" style="width: 100%; margin-top: 10px; border-collapse: collapse;"> <thead> <tr> <th style="text-align: left;">Varenummer</th> <th style="text-align: left;">Bestillingsnummer</th> </tr> </thead> <tbody> <tr> <td>Y544-120</td> <td>022686</td> </tr> </tbody> </table>	Varenummer	Bestillingsnummer	Y544-120	022686				
Varenummer	Bestillingsnummer																
Y544-120G	022742																
Y544-120B	022741																
Y544-120W	022612																
Varenummer	Bestillingsnummer																
Y544-120	022686																

## Monteringssett tilgjengelig i butikk

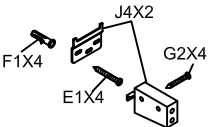
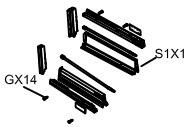
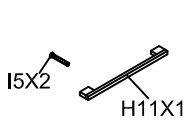
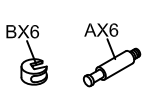
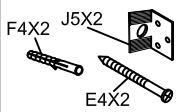
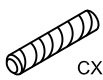
<p style="text-align: center;"><b>Brakettsett</b></p>  <p style="text-align: center;">Varenummer 0204992674</p>	<p style="text-align: center;"><b>Skinnesett skuff</b></p>  <p style="text-align: center;">Varenummer 0204992672</p>	<p style="text-align: center;"><b>Håndtaksett</b></p>  <p style="text-align: center;">Varenummer 0204992673</p>	<p style="text-align: center;"><b>Eksenterboltsett</b></p>  <p style="text-align: center;">Varenummer 0204992670</p>
<p style="text-align: center;"><b>Brakettsett</b></p>  <p style="text-align: center;">Varenummer 0204992690</p>	<p style="text-align: center;"><b>Trepluggsett</b></p>  <p style="text-align: center;">Varenummer 0204992671</p>		

## Reservedeler tilgjengelig for bestilling

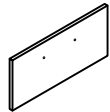
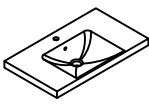
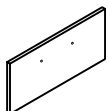
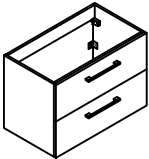
<p style="text-align: center;">øvre skuffefront</p>  <table border="1" style="width: 100%; margin-top: 10px; border-collapse: collapse;"> <thead> <tr> <th style="text-align: left;">Varenummer</th> <th style="text-align: left;">Bestillingsnummer</th> </tr> </thead> <tbody> <tr> <td>Y544-120SG</td> <td>022784</td> </tr> <tr> <td>Y544-120SB</td> <td>022622</td> </tr> <tr> <td>Y544-120SW</td> <td>022783</td> </tr> </tbody> </table>	Varenummer	Bestillingsnummer	Y544-120SG	022784	Y544-120SB	022622	Y544-120SW	022783	<p style="text-align: center;">servant</p>  <table border="1" style="width: 100%; margin-top: 10px; border-collapse: collapse;"> <thead> <tr> <th style="text-align: left;">Varenummer</th> <th style="text-align: left;">Bestillingsnummer</th> </tr> </thead> <tbody> <tr> <td>120CM</td> <td>NO10-Y544-120S-2</td> </tr> </tbody> </table>	Varenummer	Bestillingsnummer	120CM	NO10-Y544-120S-2
Varenummer	Bestillingsnummer												
Y544-120SG	022784												
Y544-120SB	022622												
Y544-120SW	022783												
Varenummer	Bestillingsnummer												
120CM	NO10-Y544-120S-2												
<p style="text-align: center;">nedre skuffefront</p>  <table border="1" style="width: 100%; margin-top: 10px; border-collapse: collapse;"> <thead> <tr> <th style="text-align: left;">Varenummer</th> <th style="text-align: left;">Bestillingsnummer</th> </tr> </thead> <tbody> <tr> <td>Y544-120SG</td> <td>022782</td> </tr> <tr> <td>Y544-120SB</td> <td>022780</td> </tr> <tr> <td>Y544-120SW</td> <td>022781</td> </tr> </tbody> </table>	Varenummer	Bestillingsnummer	Y544-120SG	022782	Y544-120SB	022780	Y544-120SW	022781	<p style="text-align: center;">underskap</p>  <table border="1" style="width: 100%; margin-top: 10px; border-collapse: collapse;"> <thead> <tr> <th style="text-align: left;">Varenummer</th> <th style="text-align: left;">Bestillingsnummer</th> </tr> </thead> <tbody> <tr> <td>120CM</td> <td>NO10-Y544-120SG-1-FSC NO10-Y544-120SB-1-FSC NO10-Y544-120SW-1-FSC</td> </tr> </tbody> </table>	Varenummer	Bestillingsnummer	120CM	NO10-Y544-120SG-1-FSC NO10-Y544-120SB-1-FSC NO10-Y544-120SW-1-FSC
Varenummer	Bestillingsnummer												
Y544-120SG	022782												
Y544-120SB	022780												
Y544-120SW	022781												
Varenummer	Bestillingsnummer												
120CM	NO10-Y544-120SG-1-FSC NO10-Y544-120SB-1-FSC NO10-Y544-120SW-1-FSC												

