

# TREND FRESH

HC1029-D900

1

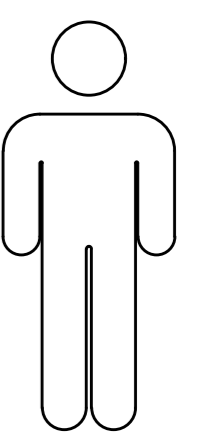
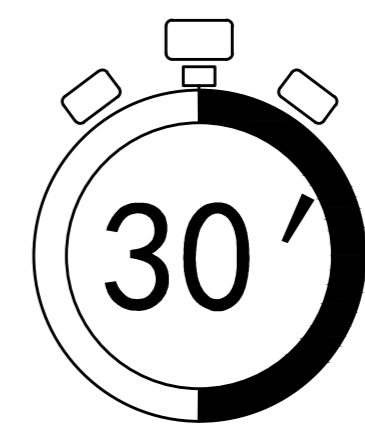
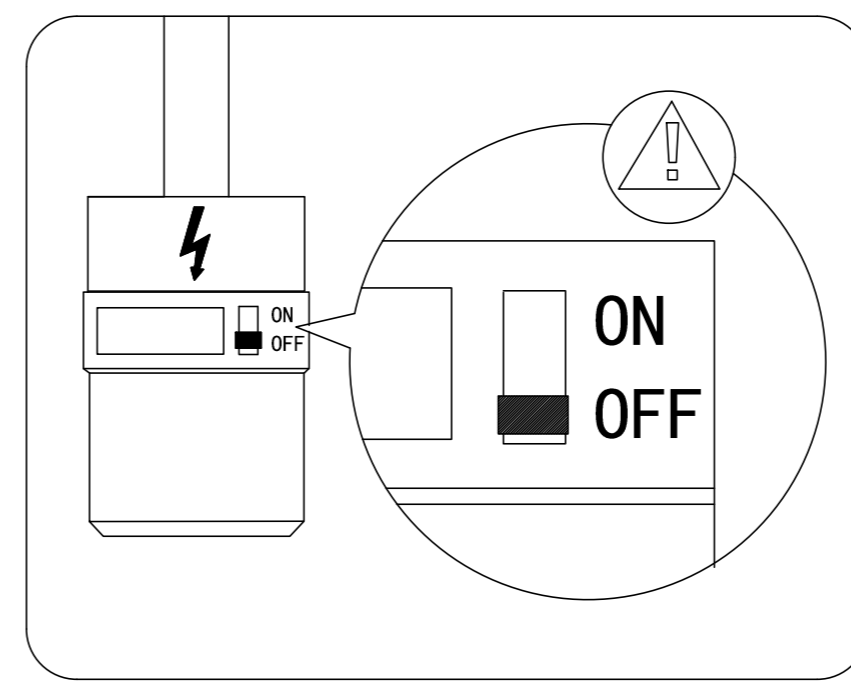
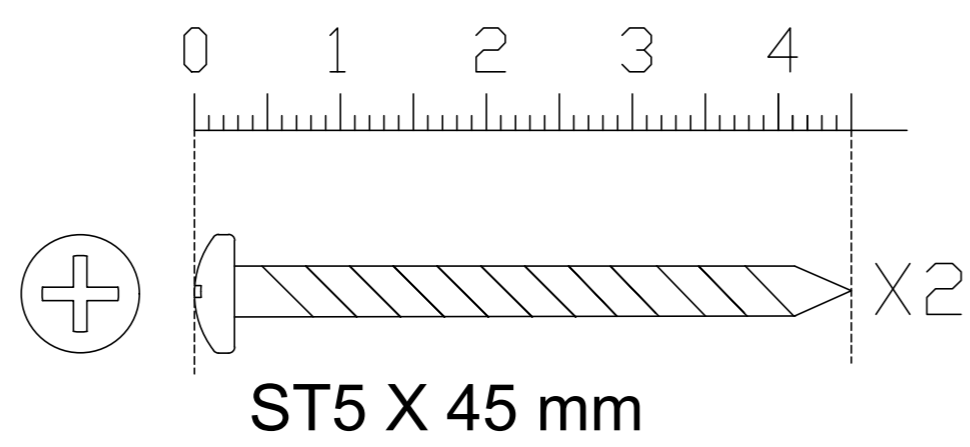
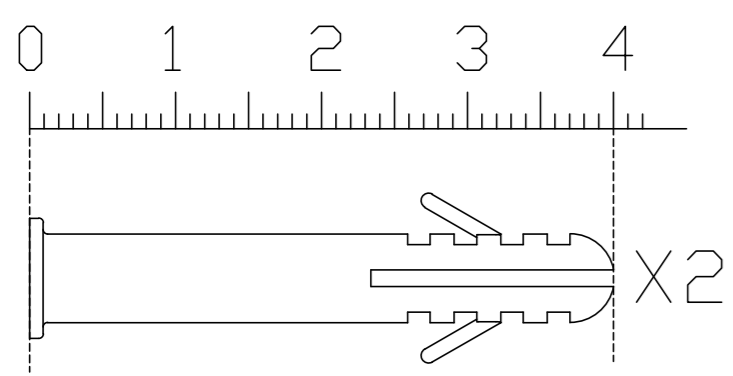
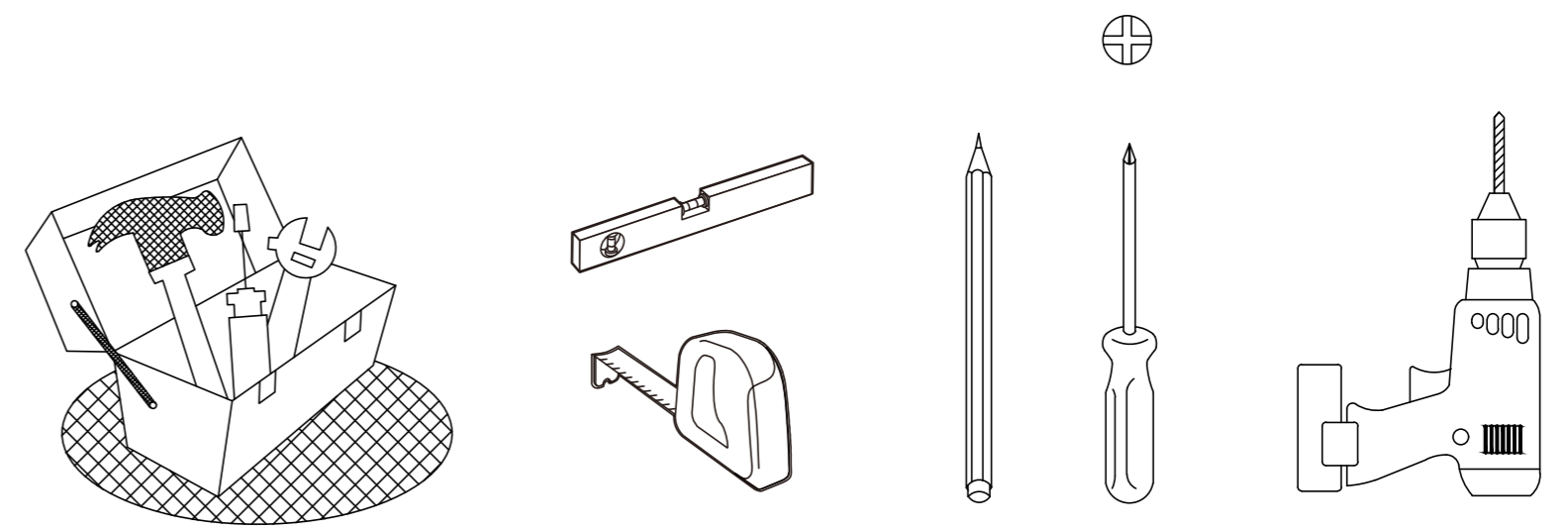
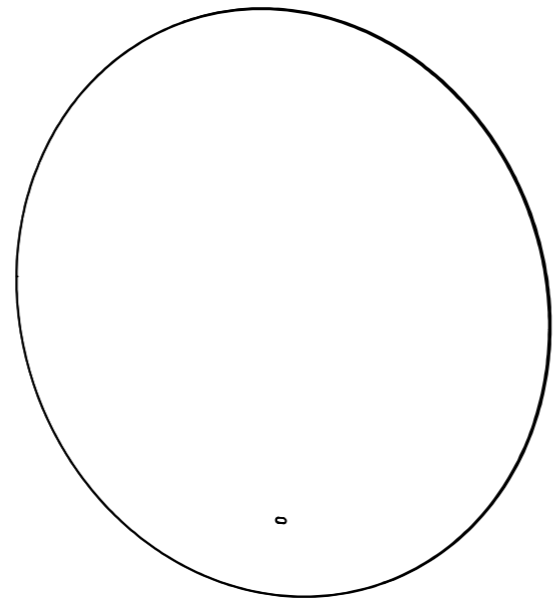
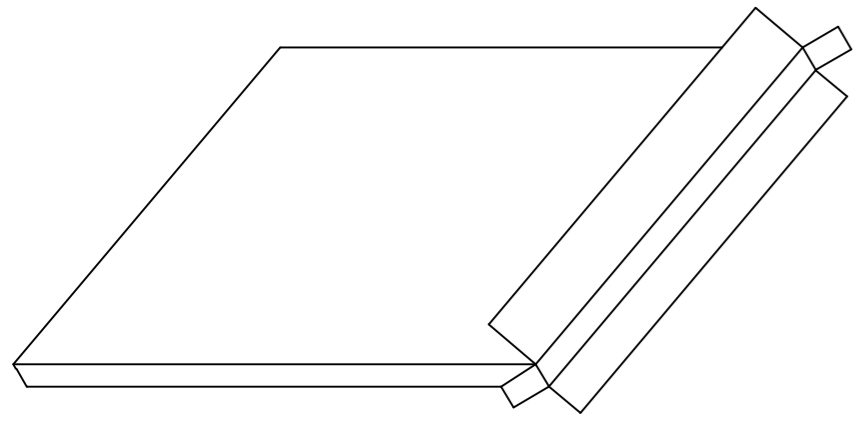

A

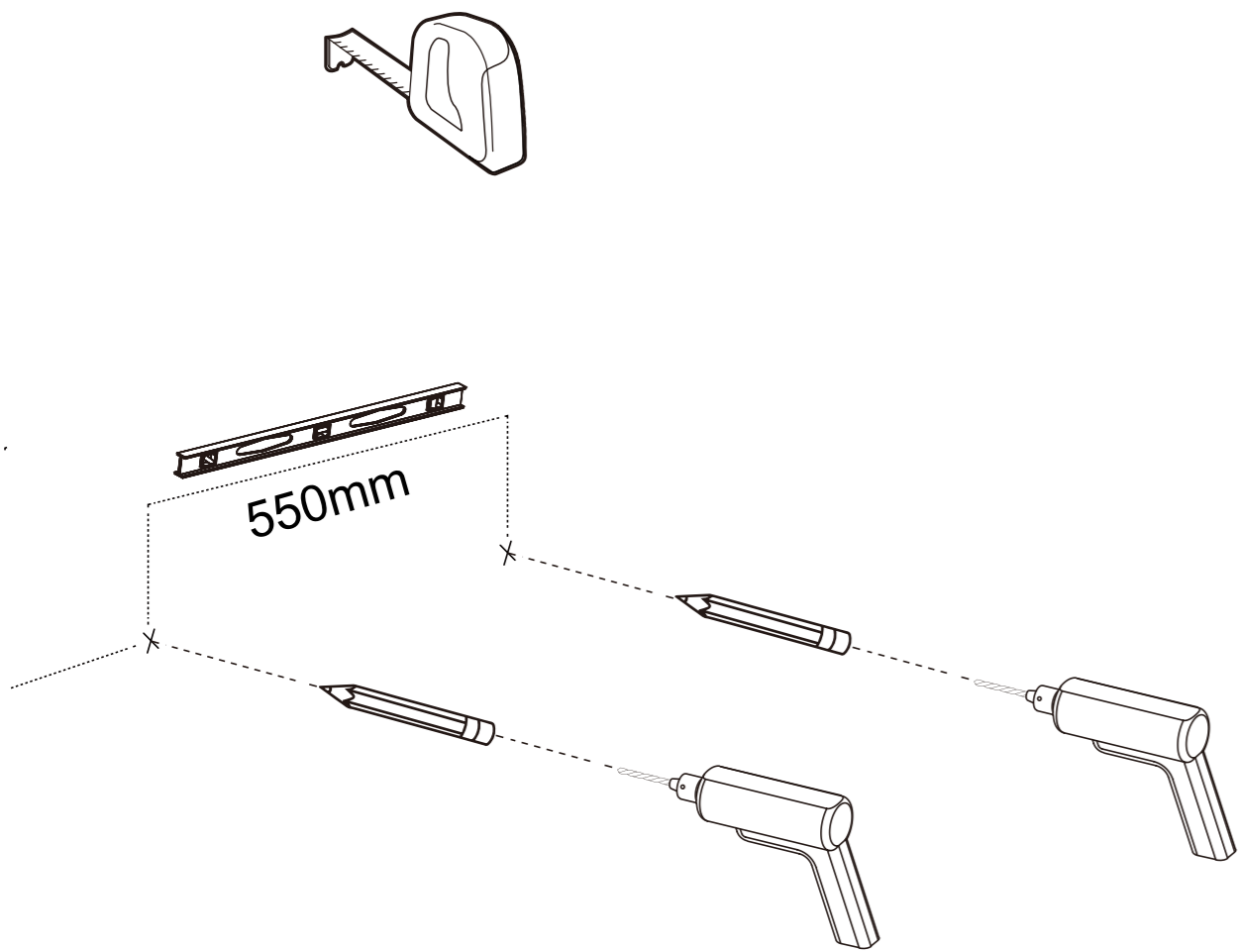

B

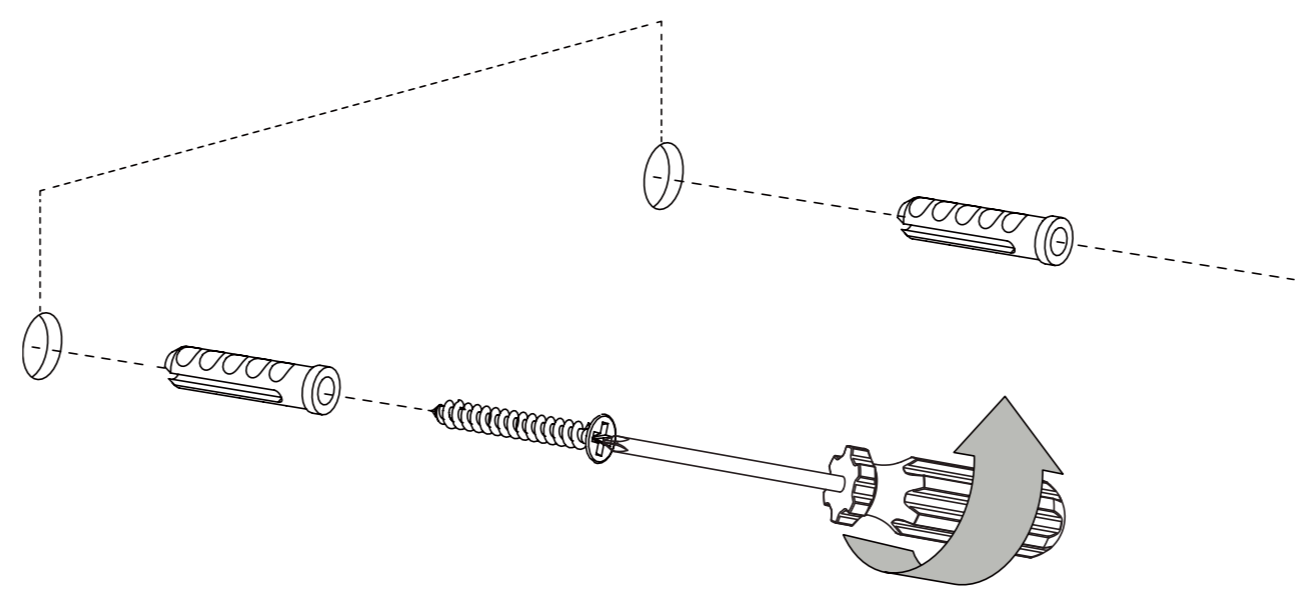

C

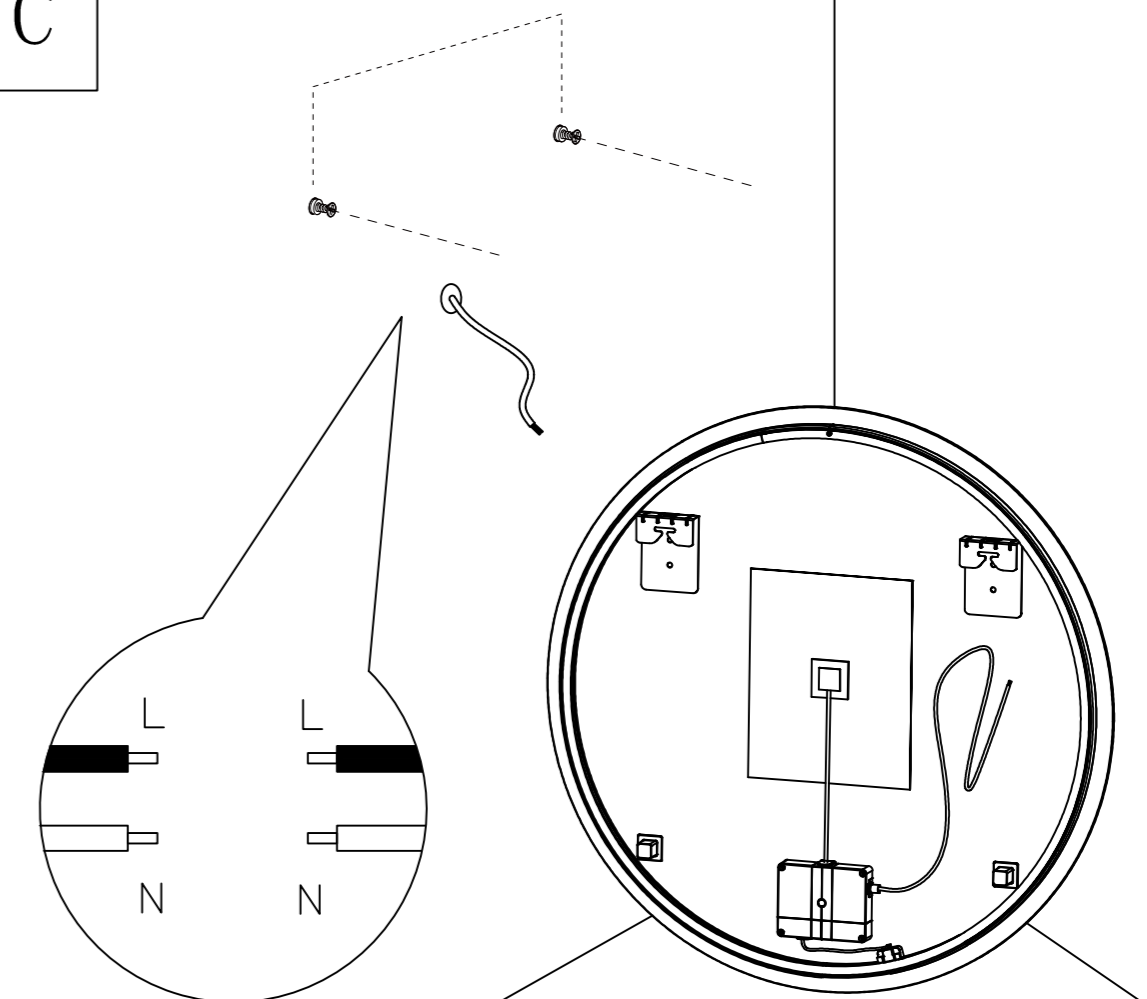

D

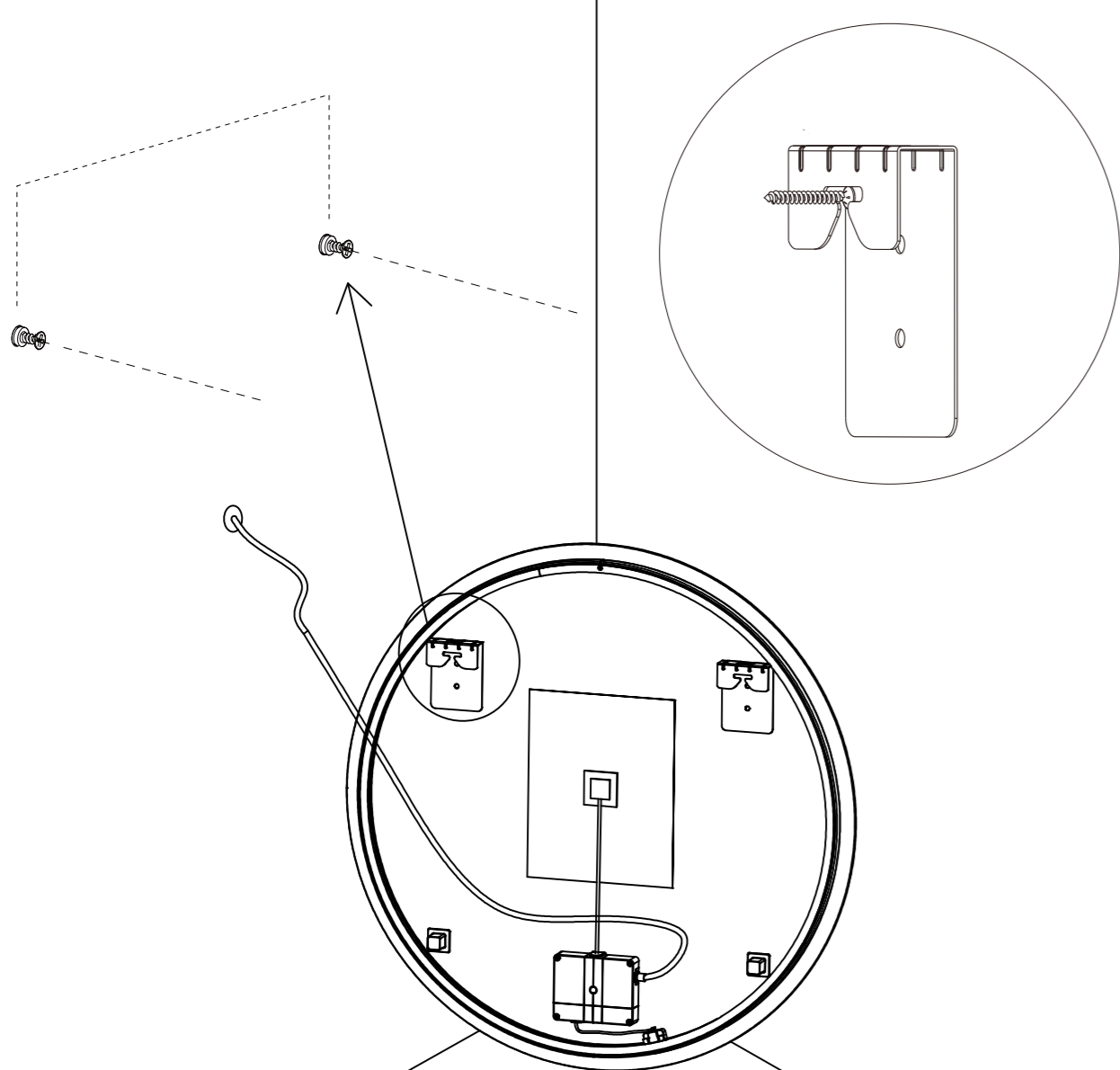

E

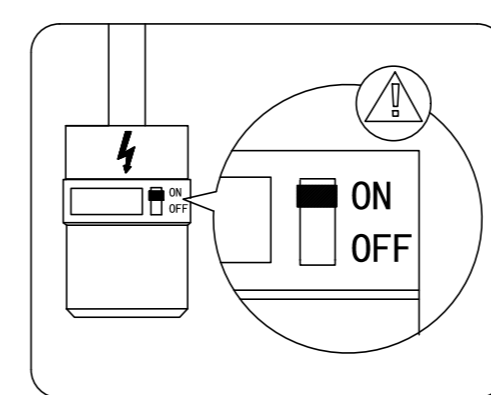
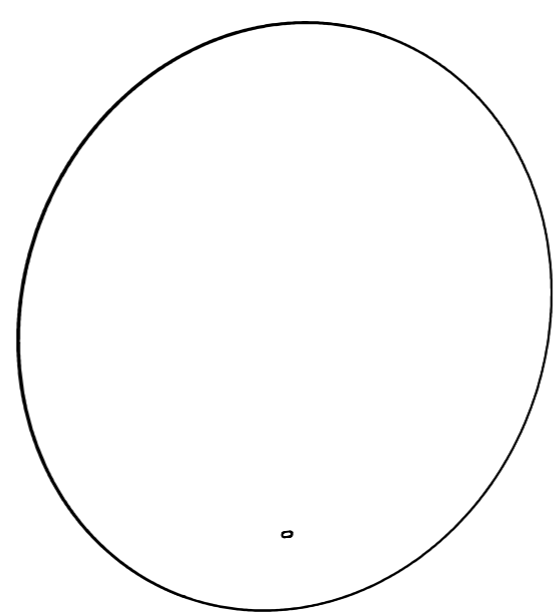

F

**1. IR sensor. Vink for å skru AV/PÅ, eller for å endre fargetemperatur: varm hvit (2700K) - AV - kald hvit (3000K).**

**2. Hold hendene foran IR-bryteren for å dimme (10% - 100% eller 100% til 10%).**

**3. Anti-dugg skrus på når lyset er på, og skrus av når lyset skrus av.**

**4. Minnefunksjon.**