

QUICKFIX

GROHE

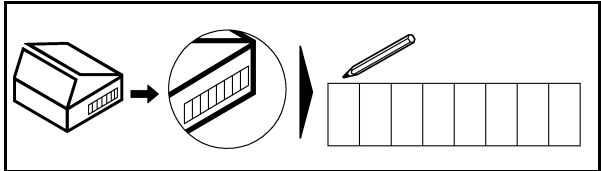

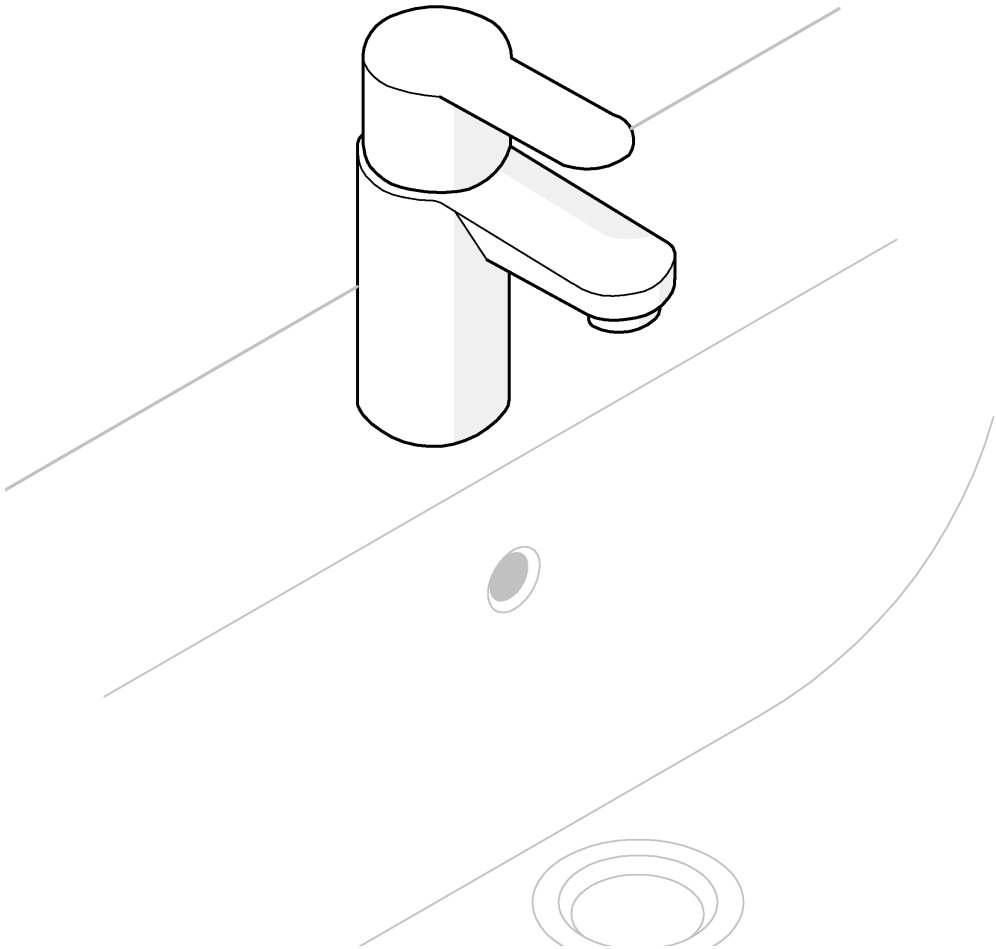

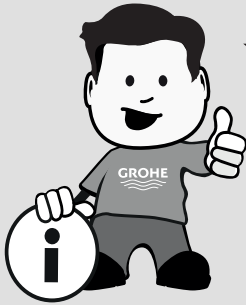

DIN 1988 !

DIN EN 1717 !

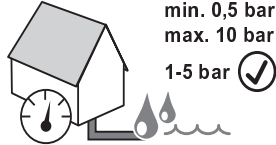
DIN EN 806 !



min. 0,5 bar
max. 10 bar
1-5 bar ✓

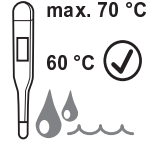

max. 70 °C
60 °C ✓

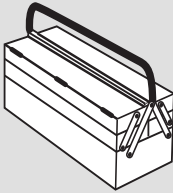

1

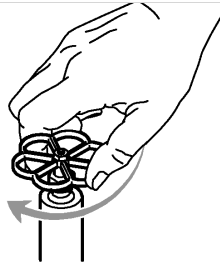

2

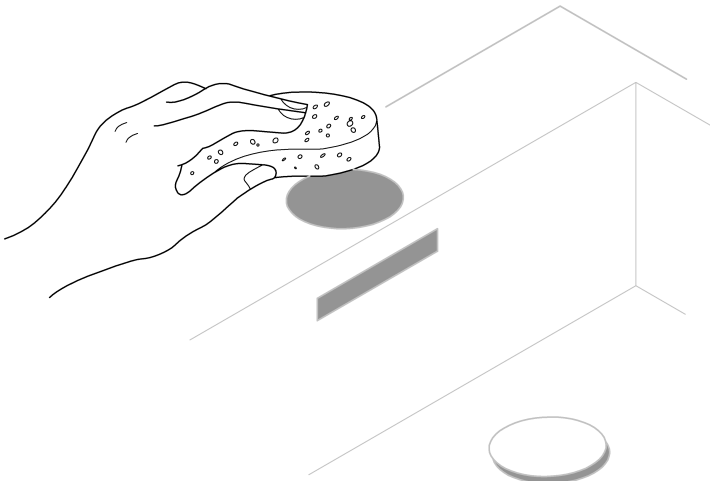

3

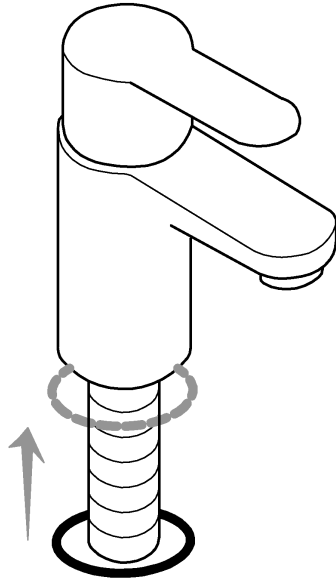

4

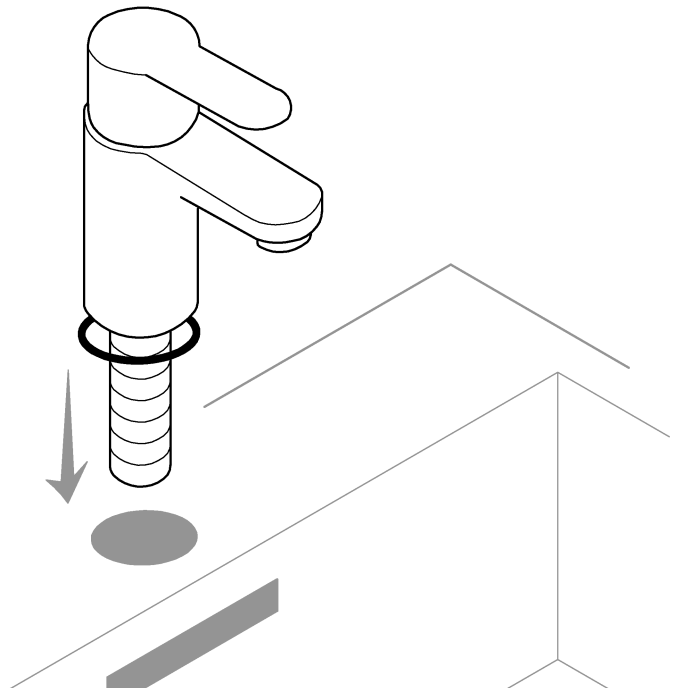

5

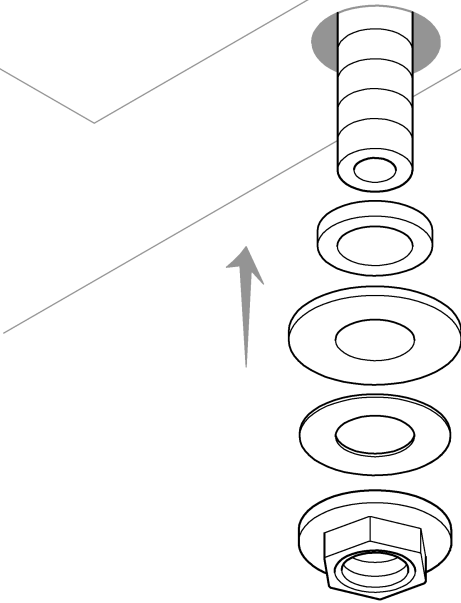

6

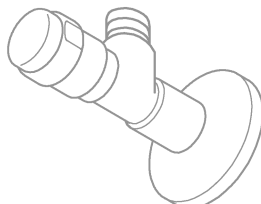
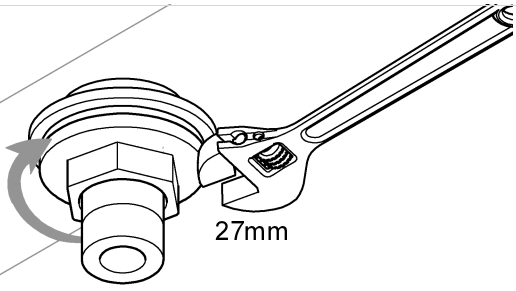

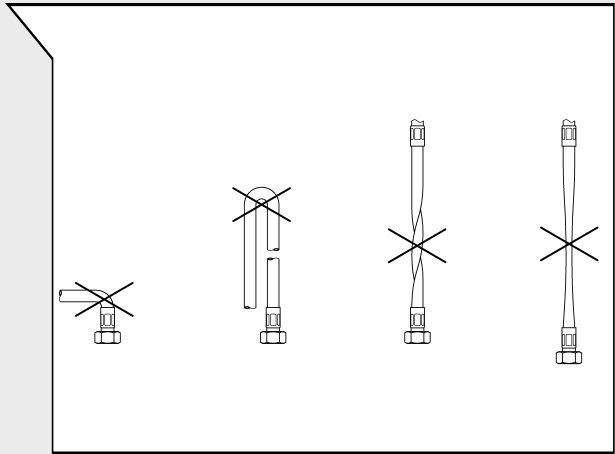
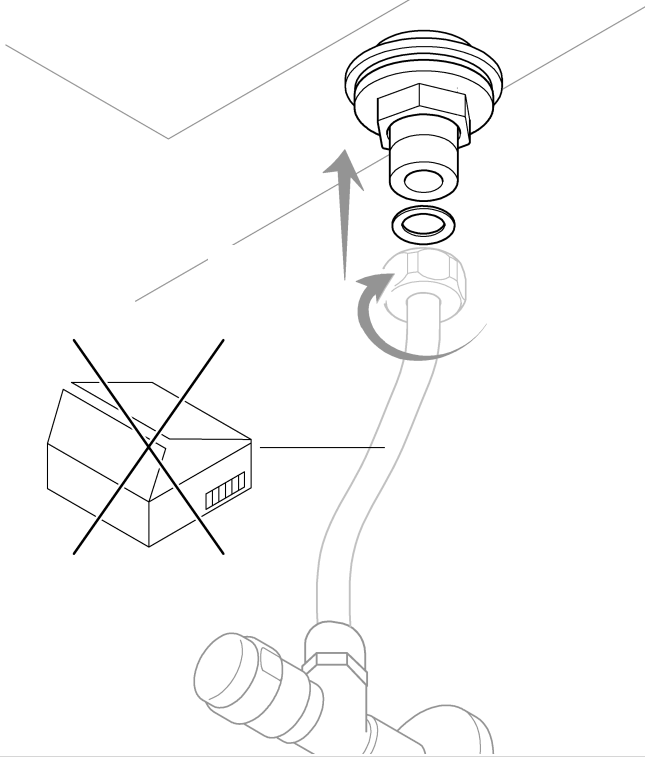

8

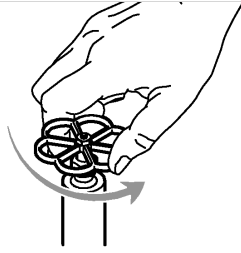

9

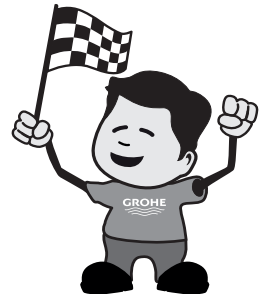
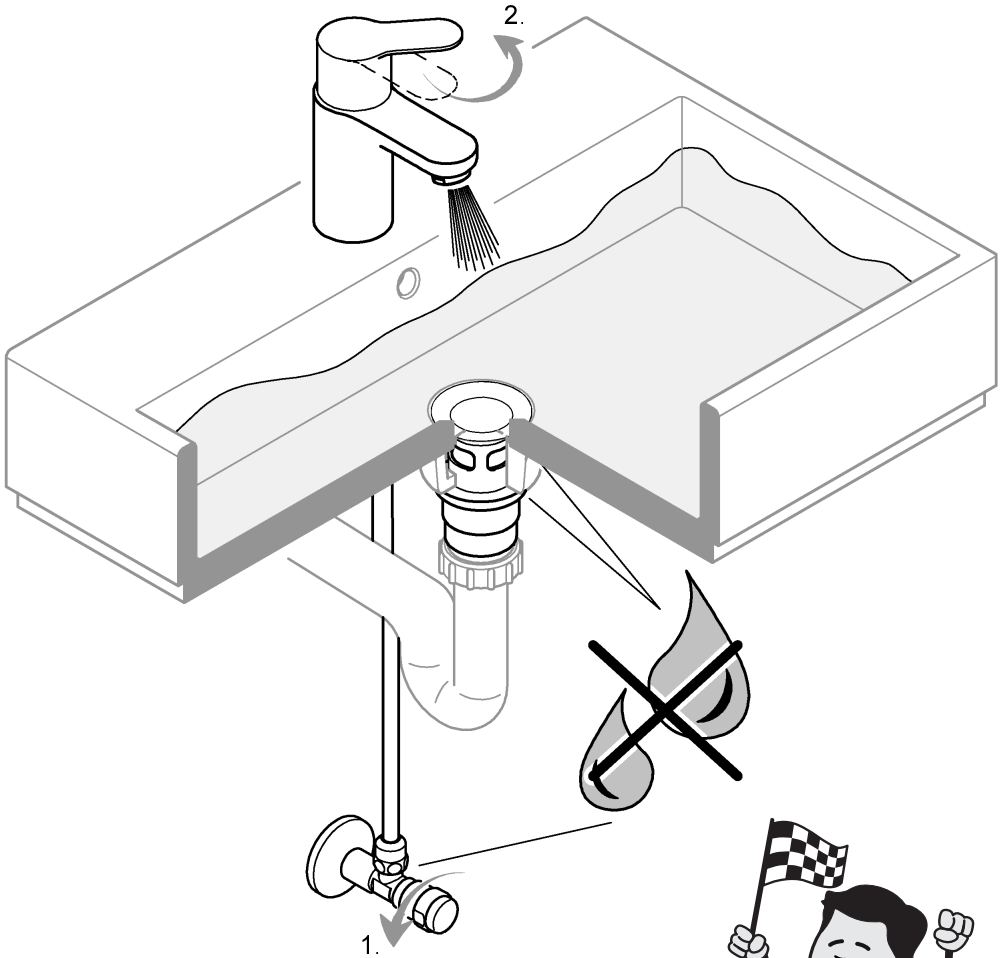

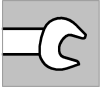
D

Die Installation muss entsprechend den geltenden örtlichen Bau- und Installationsvorschriften ausgeführt werden. Bei Unsicherheit oder Fragen, wenden Sie sich bitte an GROHE oder einen Fachmann

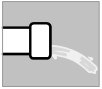

Vor der Installation sollte man Wasser durch die Leitung laufen lassen, um eventuelle Rückstände zu beseitigen. Eine Beschädigung des Produktes kann so vermieden werden.

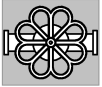

Hauptahn der Wasserzufuhr vor dem Auswechseln der Armatur abdrehen.



Die Installation der S-Anschlüsse kann anspruchsvoll sein. Um versehentliche Schäden an Ihrem Rohrleitungssystem zu vermeiden, empfehlen wir, dies von einem Fachmann durchführen zu lassen.



VORSICHT!
Schraubverbindungen auch mit eingelegrter Dichtung nicht zu fest anziehen, um Beschädigungen zu vermeiden.

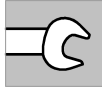

Regelmäßig kontrollieren, dass die Installation dicht ist.

GB

Installation must be performed in compliance with applicable local construction and plumbing regulations. If in doubt, contact GROHE or an expert.

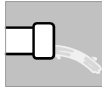

Before installation, water should be rinse through the pipe to remove any residue. Damage on the product can be avoided.

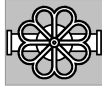

Before changing the fitting switch off main shut-off valve.



The installation of S-Unions can be complex. To avoid any accidental damages on your piping system, we recommend to do this by a qualified expert.



"CAUTION!
Do not overtighten screw connections, even with the seal inserted, to avoid damage."

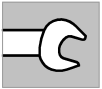

Check at regular intervals to make sure that the installation is not leaking.

F

L'installation doit être réalisée conformément aux réglementations locales de construction et d'installation. Pour toute question ou en cas de doute, n'hésitez pas à contacter GROHE ou un artisan spécialisé.



Laisser couler l'eau dans les tuyaux avant l'installation de manière à éliminer d'éventuels résidus. Cette précaution permet d'éviter l'endommagement du produit.

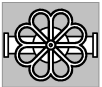

Avant de procéder au remplacement du robinet, fermer l'arrivée d'eau principale.



Le montage des raccords excentrés est assez technique. Afin d'éviter tout risque d'endommagement du système de canalisation, nous recommandons de faire appel à un artisan spécialisé pour réaliser cette opération.



"ATTENTION !
Pour éviter tout dommage, ne pas trop serrer les vis, même munies d'un joint."

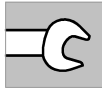

Contrôler régulièrement l'étanchéité de l'installation.

E

La instalación debe realizarse según las normativas locales en vigor de construcción e instalación. En caso de dudas, póngase en contacto con GROHE o con un profesional.

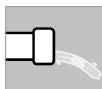

Antes de la instalación, debe dejar fluir el agua por la tubería para eliminar los posibles restos. De ese modo podrá evitar desperfectos en el producto.

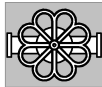

Cierre la llave principal de la alimentación de agua antes de cambiar el grifo.



La instalación de los racores en S puede ser compleja. Para evitar que se dañe accidentalmente el sistema de tuberías, se recomienda encomendar la tarea a un profesional.



"CUIDADO:
No apriete con demasiada fuerza las uniones roscadas, incluso si está colocada la junta, a fin de evitar desperfectos."

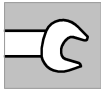

Compruebe con regularidad que la instalación sea estanca.

I

L'installazione deve essere effettuata in conformità alle norme locali in vigore per la costruzione e l'installazione. In caso di dubbi o domande, si prega di rivolgersi a GROHE o a uno specialista.



Prima dell'installazione si dovrebbe lasciar scorrere l'acqua dal lavandino per eliminare eventuali residui. In questo modo è possibile evitare un danneggiamento del prodotto.

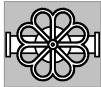

Prima di sostituire il rubinetto, chiudere il rubinetto principale dell'erogazione dell'acqua.



L'installazione dei raccordi a S può essere impegnativa. Al fine di evitare danni involontari al sistema delle condutture, si consiglia di affidare l'installazione a uno specialista.



"ATTENZIONE!

Non serrare troppo a fondo i raccordi a vite anche con guarnizione inserita per evitarne eventuali danni."

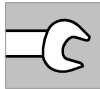

Controllare regolarmente che l'installazione sia a tenuta.

NL

De installatie moet worden uitgevoerd in overeenstemming met de geldende plaatselijke bouw- en installatievoorschriften. Neem in geval van zorgen of vragen contact op met GROHE of een vakman.

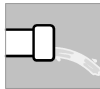

Laat vóór de installatie water door de leiding stromen om eventuele bezinksels te verwijderen. Schade aan het product kan zo worden vermeden.

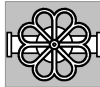

Draai de hoofdkraan van de watertoevoer dicht voordat u de kraan vervangt.



De installatie van de S-verbindingen kan veeleisend zijn. Om onopzettelijke schade aan uw leidingstelsel te voorkomen, raden we u aan dit door een vakman te laten doen.



"VOORZICHTIG!

Draai schroefverbindingen ook met geplateerde pakking niet te vast aan om beschadigingen te voorkomen."

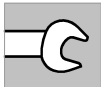

Controleer regelmatig of de installatie niet lekt.

S

Installationen måste genomföras i enlighet med de lokala bygg- och installationsföreskrifterna. Om du är osäker eller har frågor kan du kontakta GROHE eller en yrkesperson.



Innan installationen bör man spola vatten genom ledningen för att avlägsna eventuella rester. På så sätt kan man förhindra skador på produkten.

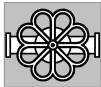

Stäng vattentillförselns huvudkran innan du byter ut blandaren.



Installationen av S-anslutningar kan vara svår. För att undvika oavsiktliga skador på rören rekommenderar vi att låta en yrkesperson utföra arbetet.



"OBS!

Dra inte åt skruvanslutningar med ilagd tätning för hårt, för att förhindra skador."

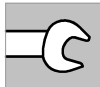

Kontrollera regelbundet att installationen är tät.

DK

Installationen skal udføres i henhold til de lokale gældende bygge- og installationsforskrifter. Ved tvivl eller spørgsmål bedes du kontakte GROHE eller en fagmand.

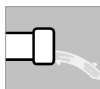

Lad vandet løbe gennem rørledningen inden installation, så eventuelle rester fjernes. På den måde kan det undgås at beskadige produktet.

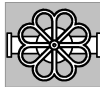

Luk for hovedhanen, inden armaturet skiftes ud.



Installation af S-forbindelserne kan være krævende. For at undgå uønskede skader på dit rørledningssystem anbefaler vi at lade en fagmand udføre installationen.



"FORSIGTIG!

For at undgå beskadigelse bør skrueforbindelserne ikke strammes for meget, heller ikke når pakningen er sat i."



Kontrollér regelmæssigt, at installationen er tæt.

N

Installasjonen må gjennomføres i samsvar med gjeldende bygge- og installasjonsforskrifter. Ta kontakt med GROHE eller en fagperson i tilfelle usikkerhet eller spørsmål.



Før installasjonen bør man la det renne vann gjennom ledningen for å fjerne eventuelle rester. Slik kan man unngå skade på produktet.



Skru av hovedkranen til vanntilførselen før utskiftingen.



Installasjonen av S-koblingene kan være krevende. For å unngå utilsiktede skader på rørledningssystemet anbefaler vi å la en fagperson gjennomføre dette.

**"FORSIKTIG!**

Ikke trekk til skruforbindelser med innlagt tetning for mye, så unngår du skader."



Kontroller regelmessig at installasjonen er tett.

FIN

Asennus on suoritettava voimassa olevien paikallisten rakennus- ja asennusmääräysten mukaisesti. Mikäli et ole varma jostakin tai sinulla on kysyttävää, ota yhteyttä GROHE-yhtiöön tai alan ammattilaiseen.



Ennen asennusta putken läpi tulisi laskea vettä, jotta mahdolliset jäämät poistuvat. Siten voidaan välttää tuotteen vaurioituminen.



Kierrä vedensyötön päähana irti ennen hanan vaihtamista.



Epäkeskiliittimien asennus voi olla haastavaa. Jotta vältetään putkiston tahaton vaurioituminen, suosittelemme, että asennus annetaan alan ammattilaisen tehtäväksi.

**"VAROITUS!**

Älä kiristä ruuviitoksia liian tiukkaan silloinkaan, kun tiiviste on paikallaan, jotta vaurioita ei synny."



Tarkista säännöllisesti, että asennus on tiivis.

PL

Montaż należy przeprowadzić zgodnie z lokalnie obowiązującymi przepisami budowlanymi i montażu. W przypadku pytań lub wątpliwości skontaktuj się z GROHE lub specjalistą.



Przed instalacją należy przepuścić przez rurę wodę, aby usunąć wszelkie pozostałości. W ten sposób można uniknąć uszkodzenia produktu.



Kran główny z doprowadzeniem wody zakręcić przed wymianą armatury.



Montaż złączek przyłączeniowych S może być wymagający. Zalecamy wykonanie tej czynności przez specjalistę, aby uniknąć przypadkowego uszkodzenia instalacji rurowej.

**"OSTRZEŻENIE!**

Nie dokręcać zbyt mocno połączeń śrubowych, nawet z założoną uszczelką, aby uniknąć uszkodzeń."



Regularnie kontrolować, czy instalacja jest szczelna.

GR

Η τοποθέτηση πρέπει να πραγματοποιείται σύμφωνα με τους ισχύοντες τοπικούς κανονισμούς κτιρίων και εγκατάστασης. Αν δεν είστε βέβαιοι ή έχετε απορίες, επικοινωνήστε με την GROHE ή έναν τεχνικό.



Πριν από την τοποθέτηση, πρέπει να διοχετεύσετε νερό μέσω του σωλήνα για να αφαιρεθούν τυχόν υπολείμματα. Μπορείτε κατά αυτόν τον τρόπο να αποφύγετε τυχόν ζημιές στο προϊόν.



Κλείστε την βρύση κύριας παροχής νερού πριν αντικαταστήσετε το εξάρτημα.



Η τοποθέτηση των συνδέσεων S ενδέχεται να είναι απαιτητική. Για να αποφύγετε να προκαλέσετε κατά λάθος ζημιά στο υδραυλικό σας σύστημα, σας συστήσουμε να αναθέσετε την εκτέλεση σε έναν τεχνικό.

**"ΠΡΟΣΟΧΗ!**

Μην σφίγγετε υπερβολικά τις βιδωτές συνδέσεις, ακόμη και με την τσιμούχα τοποθετημένη, ώστε να αποφύγετε τυχόν

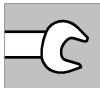

Ελέγχετε τακτικά ότι η εγκατάσταση είναι σφικτή.

CZ

Instalace musí být provedena v souladu s platnými místními stavebními a montážními předpisy. V případě nejasností nebo dotazů se obraťte na společnost GROHE nebo na odborníka.

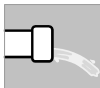

Před montáží je třeba nechat protéct vodu přes potrubí, aby se odstranily případné usazeniny. Zabráníte tak poškození výrobku.

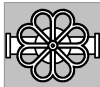

Před výměnou armatury zavřete hlavní kohoutek přívodu vody.



Instalace konektorů S může být náročná. Aby nedošlo k nechtěnému poškození potrubního systému, doporučujeme, aby tuto činnost provedl odborník.

**"UPOZORNĚNÍ!**

Šroubové spoje příliš neutahujte, a to ani s nasazeným těsněním, aby nedošlo k jejich poškození."

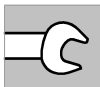

Těsnost montáže pravidelně kontrolujte.

P

A instalação deve ser realizada de acordo com os regulamentos locais de construção e instalação em vigor. Se não tiver certeza ou tiver alguma dúvida, entre em contacto com a GROHE ou com um especialista.



Antes da instalação, deve deixar correr água pelo cano para remover quaisquer resíduos. Deste modo podem ser evitados danos no produto.

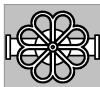

Feche a torneira principal de abastecimento de água antes de substituir a torneira.



A instalação das uniões S pode ser um desafio. Para evitar danos acidentais ao seu sistema de canalização, recomendamos que a instalação seja realizada por um profissional.

**"CUIDADO!**

Não aperte demais as uniões roscadas, mesmo com a vedação inserida, de forma a evitar danos."



Verifique regularmente se a instalação está correta.

H

A szerelést a helyileg érvényben lévő építési és szerelési előírások szerint kell elvégezni. Bizonytalanság vagy kérdés esetén, kérjük, forduljon a GROHE munkatársaihoz vagy egy szakemberhez.



Szerelés előtt folyasson át vizet a vezetéken, nehogy szennyeződés maradjon a csőben. Ezzel elkerülhető a termék károsodása.



A szerelvény lecserélése előtt zárja el a bejövő vízgáz főcsapját.



Előfordulhat, hogy az S-csatlakozók szerelése nagy odafigyelést kíván. Javasoljuk, hogy szakemberrel végeztesse el a munkát, hogy elkerülje a csővezetékrendszer véletlen sérüléseit.

**"VIGYÁZAT!**

A károsodás elkerülése érdekében a tömítés behelyezése után se húzza túl szorosra a csavarkötéseket."



Rendszeresen ellenőrizze a szerelvény tömítettségét.

TR

Montaj, geçerli yerel inşaat ve sıhhi tesisat yönetmeliklerine uygun olarak gerçekleştirilmelidir. Sorunuz veya aklınıza takılan bir şey varsa lütfen GROHE ya da bir uzman ile iletişime geçin.



Herhangi bir artığı gidermek için montajdan önce su borudan durulanmalıdır. Böylece üründe hasar oluşması önlenilir.



Bataryayı değiştirmeden önce ana su girişini kapatın.



S-bağlantılarının montajı karmaşık olabilir. Boru sisteminizin kaza sonucu hasar görmemesi için bu işlemin bir uzman tarafından gerçekleştirilmesini öneririz.

**"DİKKAT!**

Vida bağlantıları conta takılı olsa bile deformasyona neden olmamak için fazla sıkmayın."

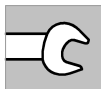

Montajın sızdırmadığından emin olmak için düzenli aralıklarla kontrol edin.

SK

Inštalácia sa musí vykonať v súlade s platnými miestnymi stavebnými a inštaláčnymi predpismi. Ak si nie ste istí alebo máte akékoľvek otázky, kontaktujte spoločnosť GROHE alebo odborníka.

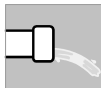

Pred inštaláciou by sa malo potrubie prepláchnuť vodou, aby sa odstránili všetky zvyšky. Tým sa dá predísť poškodeniu výrobu.

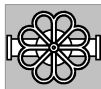

Pred výmenou armatúry vypnite hlavný prívod vody.



Inštalácia S-prípojok môže byť náročná. Aby ste predišli neúmyselnému poškodeniu potrubného systému, odporúčame, aby túto činnosť vykonal odborník.

**"UPOZORNENIE!**

Aby nedošlo k poškodeniam, skrutkové spoje neutahajte príliš silno, a to ani pri vloženom tesnení."

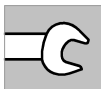

Pravidelne kontrolujte, či inštalácia dobre tesní.

SLO

Inštalacijo morate izvesti ustrezno z veljavnimi krajevnimi gradbenimi in inštalacijskimi predpisi. V primeru nejasnosti ali vprašanj se obrnite na družbo GROHE ali strokovnjaka.

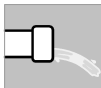

Pred inštalacijo pustite teči vodo skozi napeljavo, s čimer odstranite morebitne ostanke. Tako lahko preprečite poškodbo proizvoda.

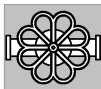

Pred menjavanjem armature zaprite glavni ventil za dovajanje vode.



Inštalacija S-priključkov je lahko zahtevna. Da bi se izognili nenamernim poškodbam vsega cevne sistema, priporočamo, da inštalacijo opravi strokovnjak.

**"PREVIDNO!**

Vijačnih povezav tudi z vložnim tesnilom ne privijte premočno, s čimer preprečite poškodbe."

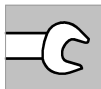

Redno preverjajte, da inštalacija tesni.

HR

Ugradnja se mora izvesti u skladu s važećim lokalnim propisima o gradnji i ugradnji. U slučaju nejasnoća ili pitanja obratite se društvu GROHE ili stručnjaku.

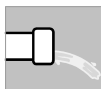

Prije ugradnje treba pustiti vodu da prođe kroz cijev kako bi se uklonili eventualni ostaci. Na taj način se možete izbjeći oštećenje proizvoda.

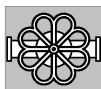

Prije zamjene armature zatvorite glavni ventil za dovod vode.



Ugradnja S-priključaka može biti složena. Da biste spriječili slučajna oštećenja na sustavu cjevovoda, preporučujemo da radove izvodí stručnjak.

**"OPREZ!**

Čak i s umetnutim brtvilom suviše ne zatežite vijčane spojeve, kako biste izbjegli oštećenja."

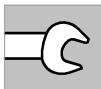

Redovito provjeravajte je li instalacija dobro zabrtvljena odnosno nepropusna.

BG

Монтажът трябва да се извърши според приложените местни строителни и монтажни разпоредби. В случай че не сте сигурни или ако имате въпроси, обърнете се към GROHE или към специалист.



Преди монтаж трябва да се остави да тече вода от тръбопровода, за да се отстранят евентуални остатъци. Така може да бъде избегната повреда на продукта.

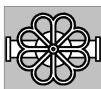

Развийте основния кран за пускане на водата преди смяната на батерията.



Инсталирането на S-връзките може да се окаже предизвикателство. За да избегнете неволни повреди на водопроводната инсталация, препоръчваме това да бъде направено от специалист.

**"ВНИМАНИЕ!**

За да избегнете повреди, не затягйте винтовите съединения, дори и с поставен уплътнител."

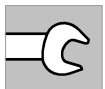

Редовно контролирайте монтажа за течове.

EST

Paigaldage kohalike ehitus- ja paigaldusnõuete kohaselt. Kui te pole kindel või teil on küsimusi, võtke ühendust GROHE või spetsialistiga.



Enne paigaldamist laske veel läbi paigaldise joosta, et võimalikud jäägid eemaldada. Nii saab vältida toote kahjustumist.

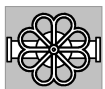

Keerake vee juurdevoolu peakraan enne armatuuri vahetamist lahti.



S-liideste paigaldamine võib olla keeruline. Veesüsteemi juhusliku kahjustamise vältimiseks soovitame lasta tööd teha professionaalil.

**"ETTEVAATUST!**

Kahjustuste vältimiseks ärge keerake keermesühendusi koos tihendiga liiga tugevasti kinni."

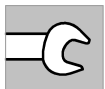

Kontrollige regulaarselt paigalduse lekkekindlust.

LV

Uzstādīšana jāveic saskaņā ar spēkā esošajiem vietējiem būvniecības un uzstādīšanas noteikumiem. Šaubu vai jautājumu gadījumā, lūdzu, sazinieties ar GROHE vai speciālistu.



Pirms uzstādīšanas caur cauruli jāplūst ūdenim, lai noņemtu iespējamus atlikumus. Tādējādi var izvairīties no izstrādājuma bojājumiem.

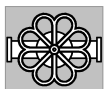

Pirms armatūras nomaiņas aizveriet galveno ūdens pievadīšanas krānu.



S veida pieslēgumu uzstādīšana var būt sarežģīta. Lai izvairītos no nejaušiem cauruļvadu sistēmas bojājumiem, uzstādīšanu ieteicams veikt speciālistam.

**"UZMANĪBU!**

Lai izvairītos no bojājumiem, nepievelciet skrūsvienojumus pārāk cieši pat tad, ja ir ievietots blīvējums."

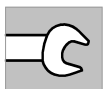

Regulāri pārbaudiet uzstādīšanas blīvumu.

LT

Įrengimas turi būti atliekamas laikantis galiojančių vietinių statybos ir įrengimo taisyklių. Jei abejojate arba turite klausimų, kreipkitės į GROHE arba specialistą.

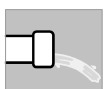

Prieš įrengiant vandentiekio liniją, per ją reikia perleisti vandenį, kad būtų pašalinti galimi likučiai. Taip galima išvengti gaminio pažeidimo.

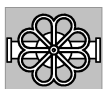

Prieš keisdami jungtį užsukite pagrindinį vandens tiekimo maišytuvą.



S jungčių įrengimas gali būti sudėtingas. Kad išvengtumėte atsitiktinės žalos vamzdynų sistemai, rekomenduojame, kad tai atliktų specialistas.

**"DĖMESIO!**

Neužveržkite varžtinių jungčių pernelyg stipriai, net ir esant uždėtam sandarikliui, kad jų nepažeistumėte."

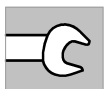

Reguliariai patikrinkite, ar įrenginys yra sandarus.

RO

Instalarea trebuie efectuată conform reglementărilor locale de construcție și de instalare în vigoare. Dacă nu sunteți sigur sau aveți întrebări, vă rugăm să contactați GROHE sau un specialist.

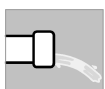

Înainte de instalare, trebuie să lăsați să curgă apa prin conductă, pentru a îndepărta eventuale reziduuri. Astfel se poate evita o posibilă deteriorare a produsului.

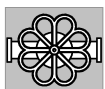

Desfaceți prin rotire robinetul principal al alimentării cu apă înainte de schimbarea bateriei.



Instalarea racordurilor în S poate reprezenta o provocare. Pentru a evita deteriorarea accidentală a sistemului dumneavoastră de conducte, vă recomandăm ca acest lucru să fie efectuat de către un profesionist.

**"ATENȚIE!**

Nu strângeți prea tare racordurile filetate, chiar și cu garnitura aplicată, pentru a evita deteriorările."



Controlați regulat dacă instalația este etanșă.