

LAUFEN PRO

Vanity unit, 1 drawer, matches washbasin
818952

DIMENSIONS

Length	520 mm
Width	450 mm
Height	390 mm

COLOUR AND FINISH

463 White

SPECIFICATION TEXT

Body/Front – MDF board with PVC foil, Integrated handle in the front

MOUNTING ACCESSORIES INCLUDED

Installation set for furniture, order no. 491206, 491140

MOUNTING ACCESSORIES EXCLUDED

Space saving siphon, order no. 894240

Adjustable legs

Basin position : Central

Basin type : Vanity

Doors and drawers combination : 1 drawer

Furniture configuration : Drawers

Internal drawers : 0

Internal shelves : 0

Legs included : 0

Net weight (kg) : 18.1

Taphole configuration : No tapholes

TECHNICAL DRAWINGS

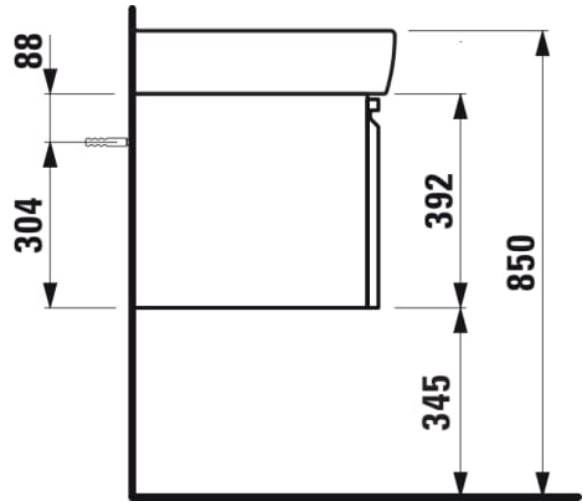
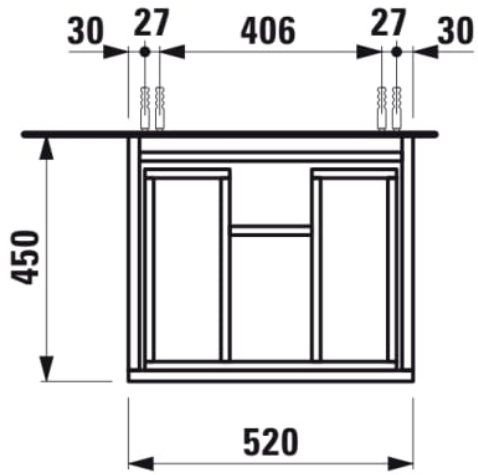

COMPATIBLE WITH



Washbasin

H818952...1041

COMPATIBLE WITH



Set of adjustable feet (2 pieces), height 355 mm, anodized aluminium surface

H4830920950041



LAUFEN PRO

LAUFEN pro is a comprehensive bathroom range, which offers the ideal solution for every spatial situation and requirement and also reflects the building values of the current generation. Industrial design is the modern answer to the once revolutionary idea that everyone has a right to enjoy beautiful forms. Good design is now no longer a right reserved for the most affluent customers. Modern methods of industrial production and designers such as Peter Wirz of Vetica, who put optimum manufacturing feasibility at the forefront of their creative processes, make such sanitary ware ranges as LAUFEN pro possible. This does not just benefit the designer, more importantly, it also benefits the custo

