

LAUFEN PRO S

Vanity unit, 1 drawer, matches washbasin
813966



DIMENSIONS

Length	1010 mm
Width	450 mm
Height	390 mm

COLOUR AND FINISH

■ 480 Graphite

SPECIFICATION TEXT

Body/Front – MDF board with PVC foil Integrated handle in the front

MOUNTING ACCESSORIES INCLUDED

Installation set for furniture, order no. 49120.6.,49114.0

MOUNTING ACCESSORIES EXCLUDED

Feet (2 pieces), aluminium, order no. 483101.Towel rail, anodized aluminium, order no. 490952.Space saving siphon, order no. 894240

Adjustable legs

Installation type : Wall-hung

Taphole configuration : No tapholes

Basin position : Central

Internal drawers : 0

Basin type : Vanity

Internal shelves : 0

Doors and drawers combination : 1 drawer

Legs included : 0

Furniture configuration : Drawers

Net weight (kg) : 26

TECHNICAL DRAWINGS

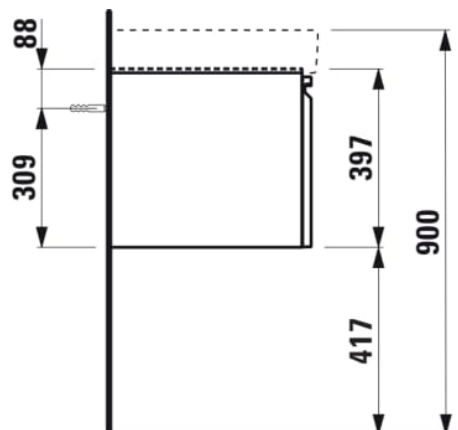
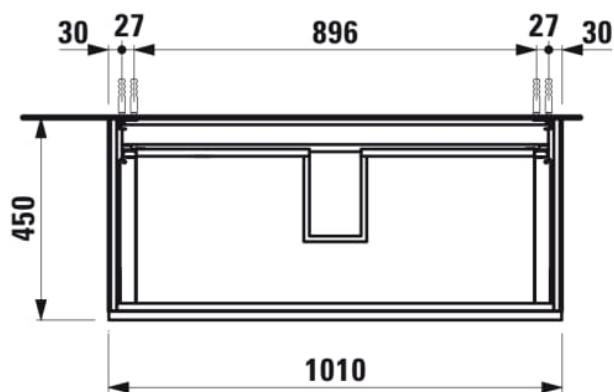

COMPATIBLE WITH



Washbasin

H813966...1041



Towel holder for furniture,
400 mm

H490952...0001

COMPATIBLE WITH



Set of adjustable feet (2
pieces), height 415 mm,
anodized aluminium
surface

H4831010960041

LAUFEN PRO S

LAUFEN pro S is the new member of the successful LAUFEN pro series. Thanks to the delicate redesign, the elegant pro S is compatible with all pro variants.

